

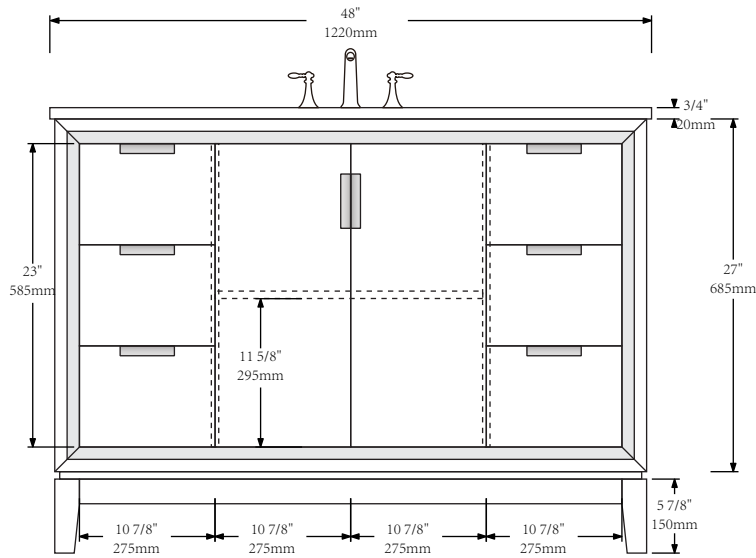

MODEL: ELIZABETH48

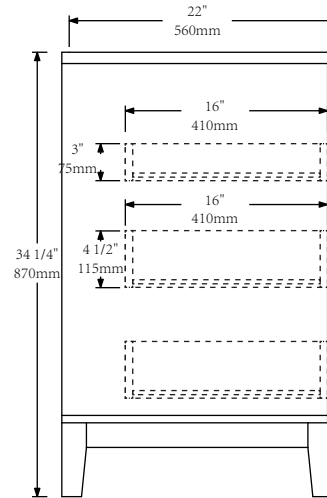

FRONT VIEW



SIDE VIEW

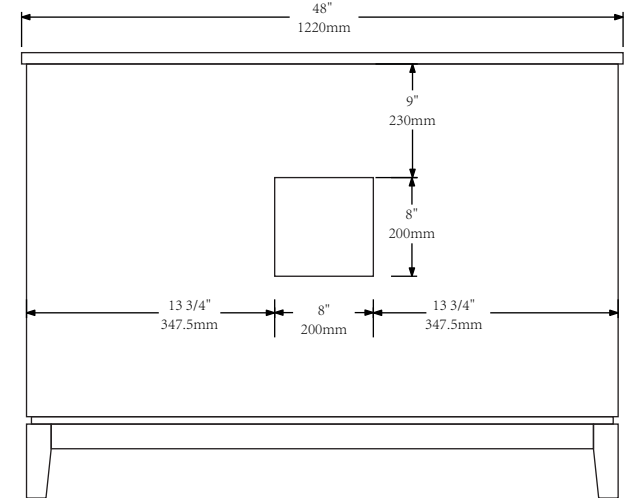

BACK VIEW



MODEL: ELIZABETH48

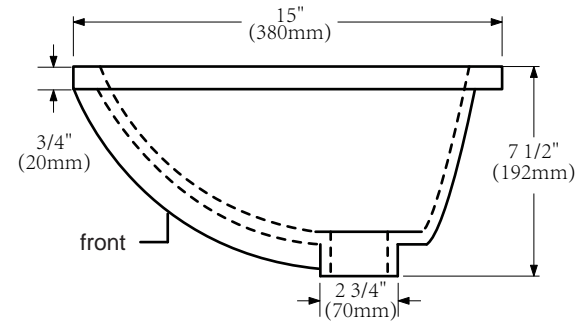
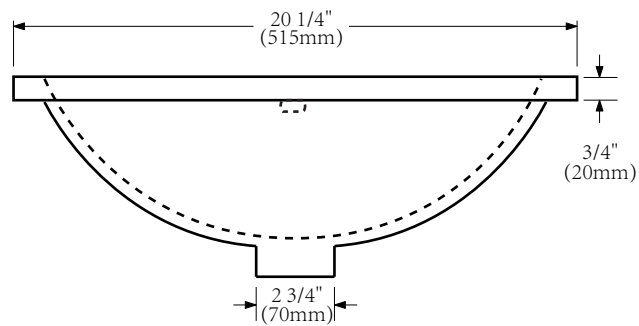
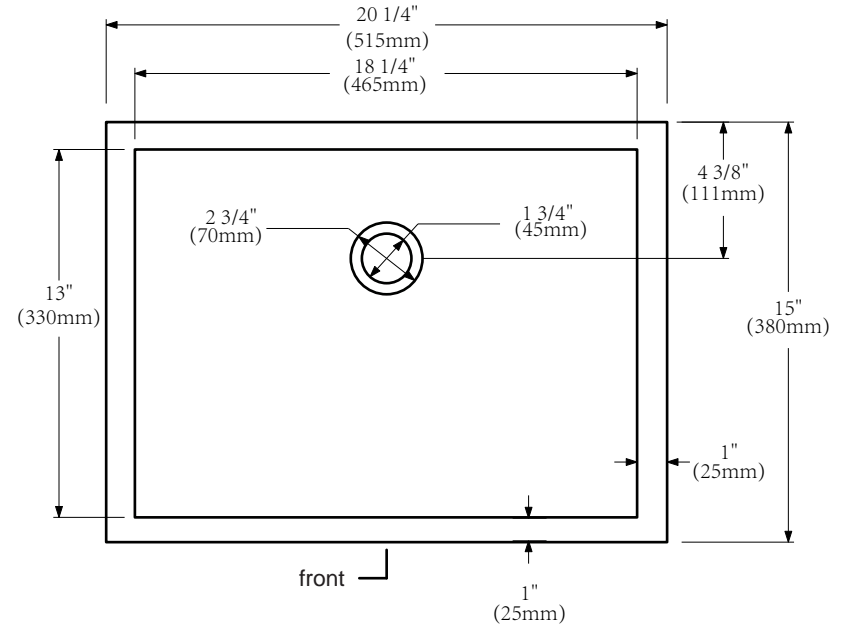
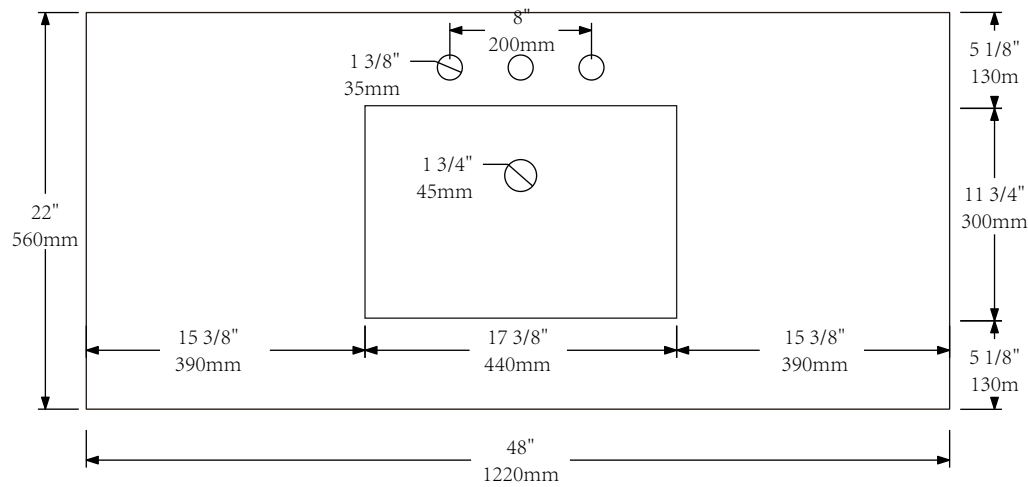



MODEL: F2-0012

