

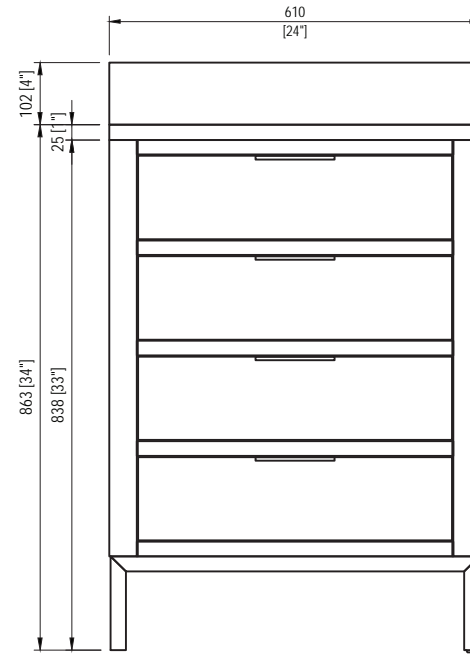

MODEL: BRISTOL 24

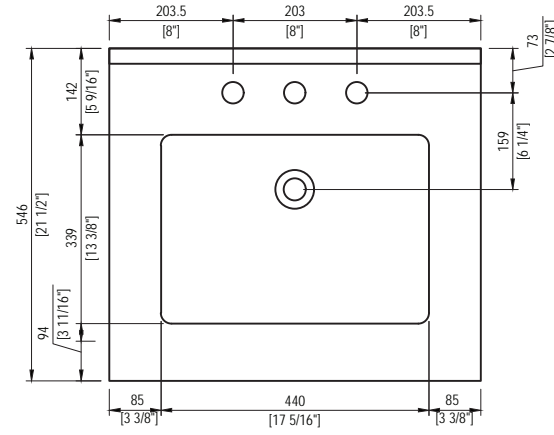

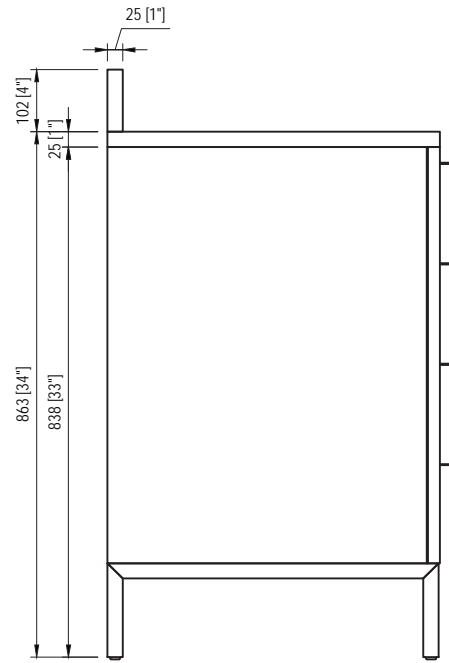

MODEL: BRISTOL 24

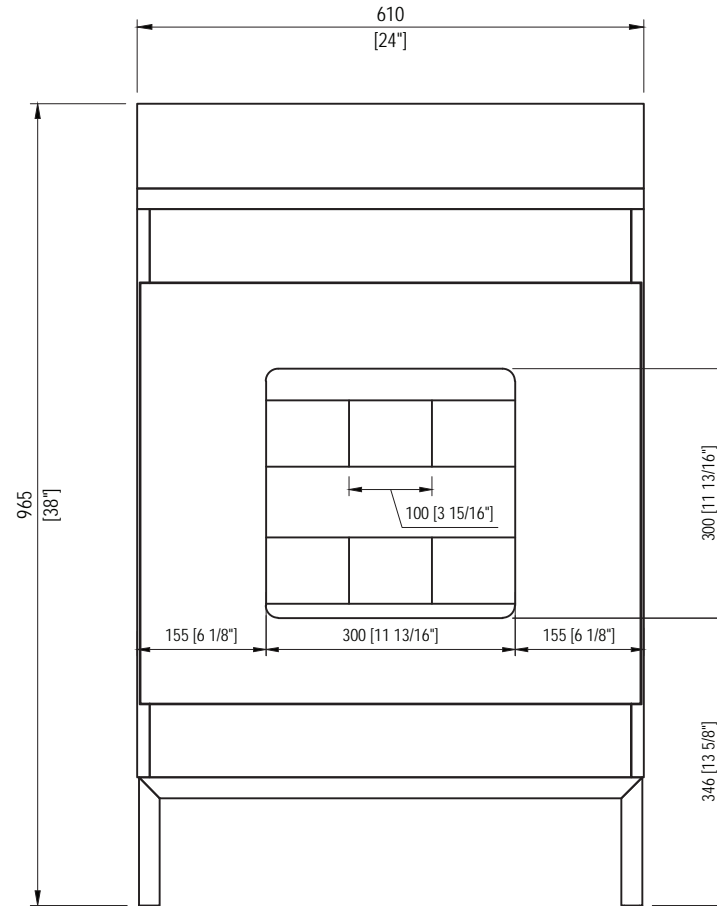



MODEL: BRISTOL 24

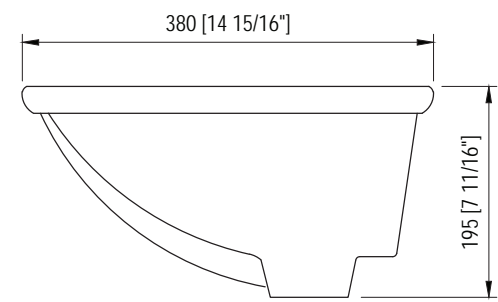
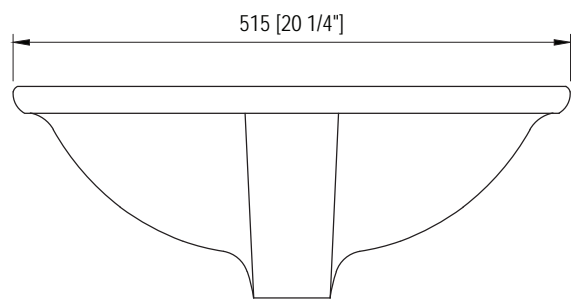
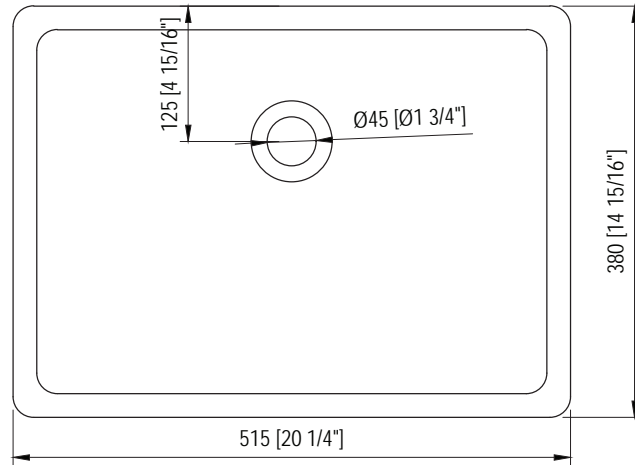



MODEL: BRISTOL 24

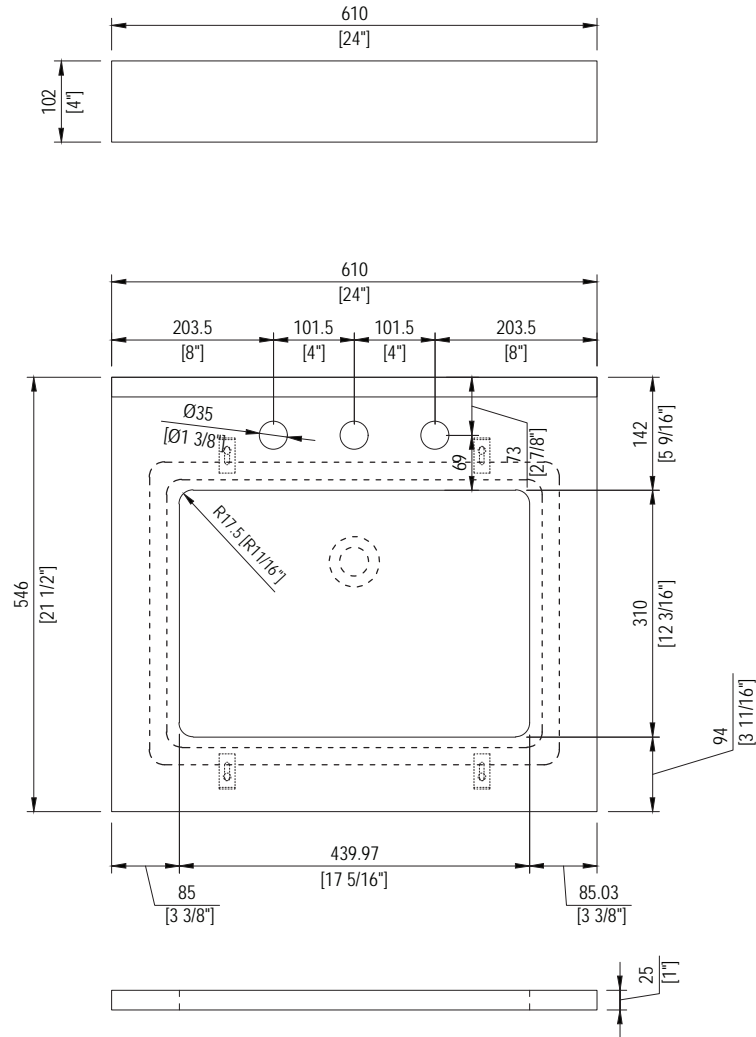



WATER CREATION

MODEL: BRISTOL 24

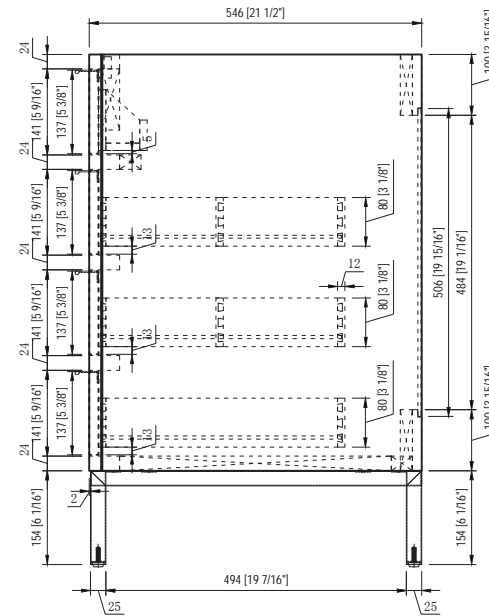
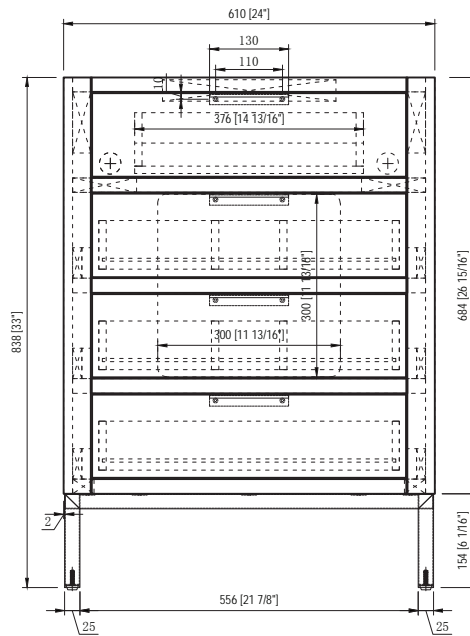
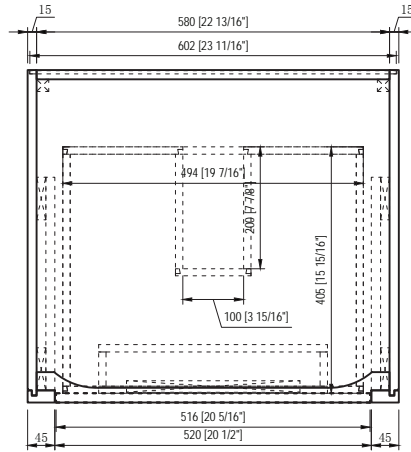



MODEL: F2-0014

