

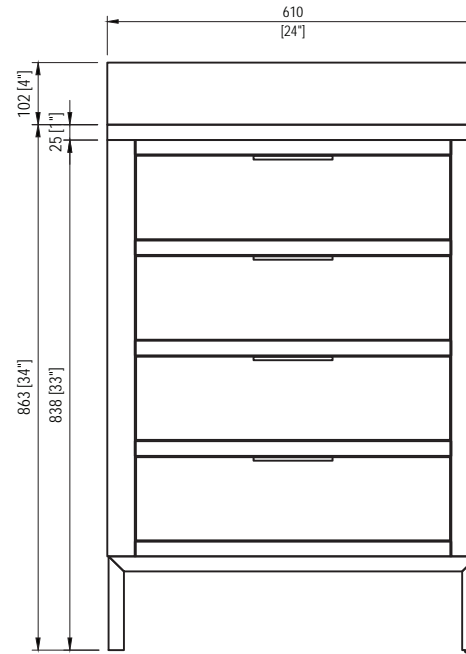

# MODEL: BRISTOL 24

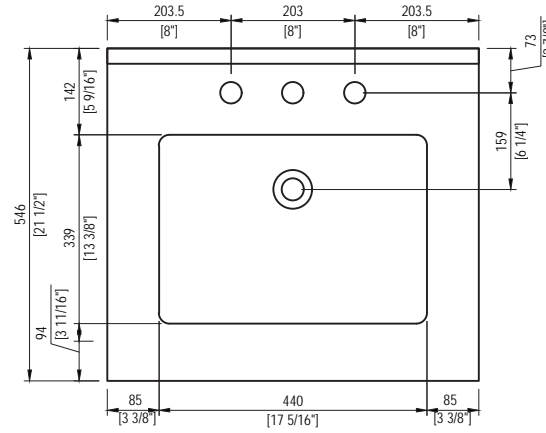

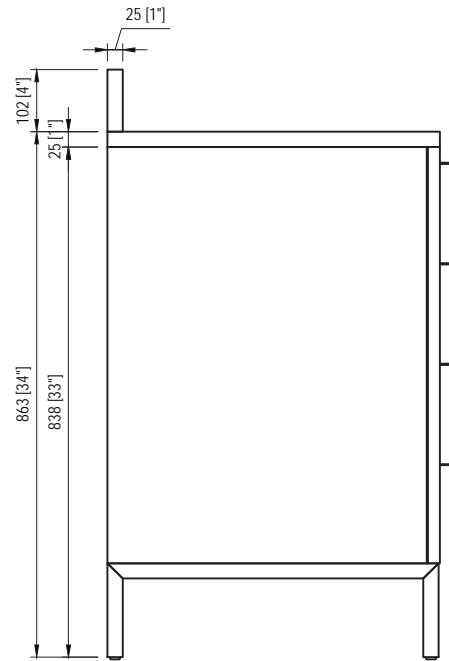

MODEL: BRISTOL 24

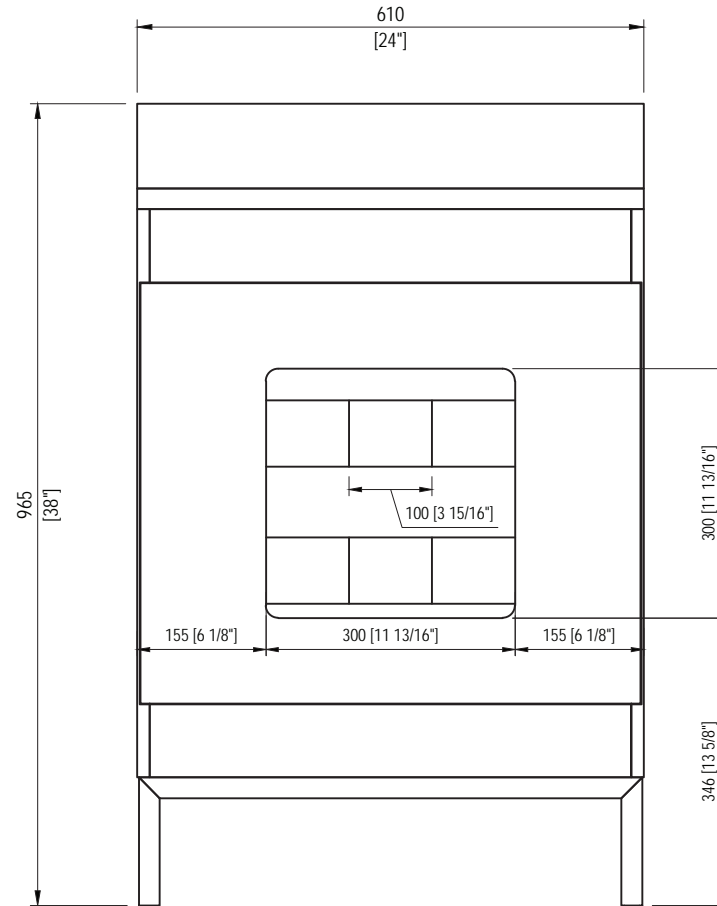



MODEL: BRISTOL 24

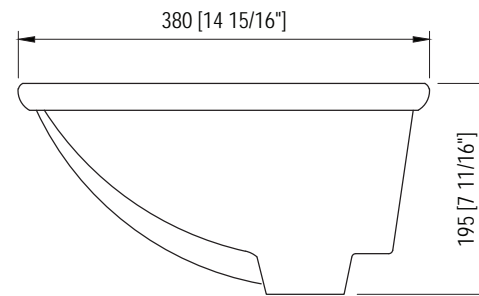
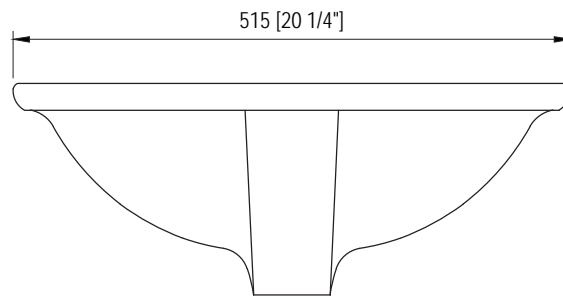
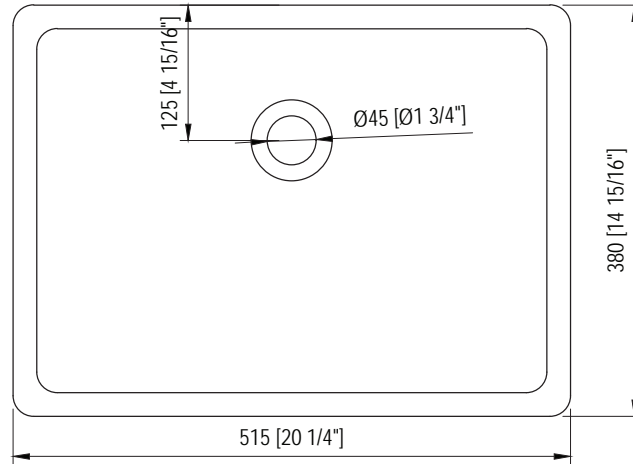



# MODEL: BRISTOL 24

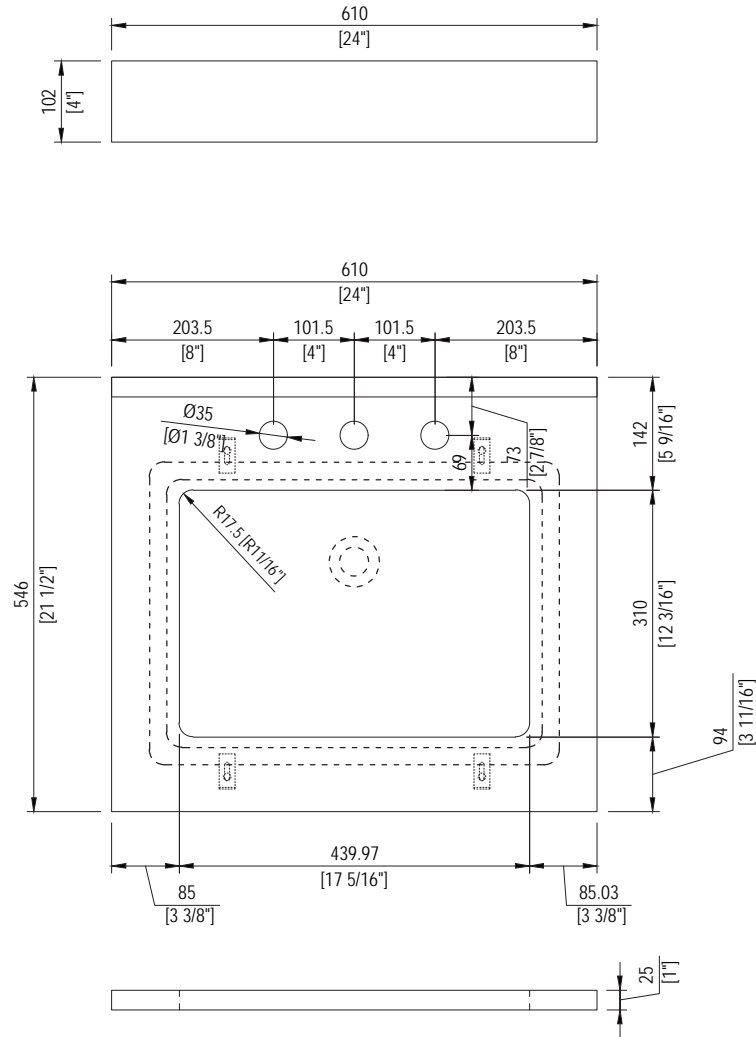



WATER CREATION

# MODEL: BRISTOL 24

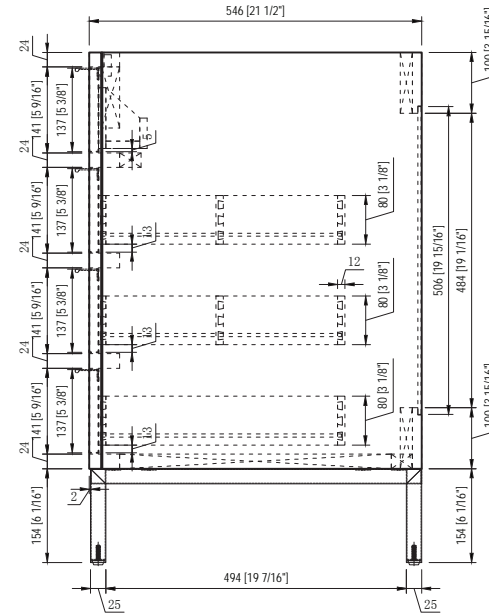
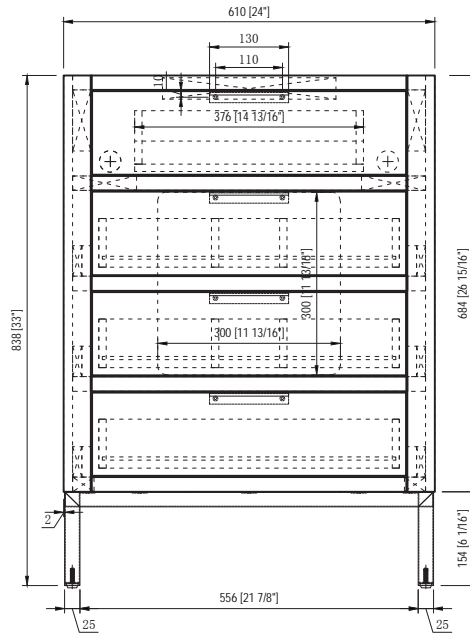
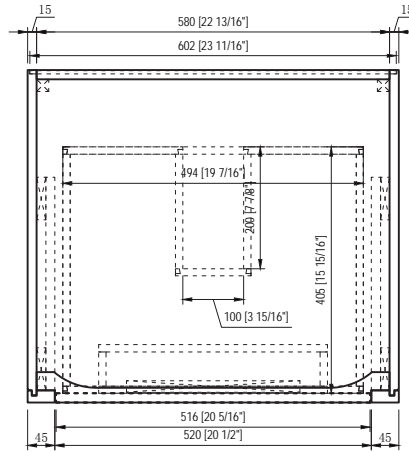



MODEL: F2-0014

