

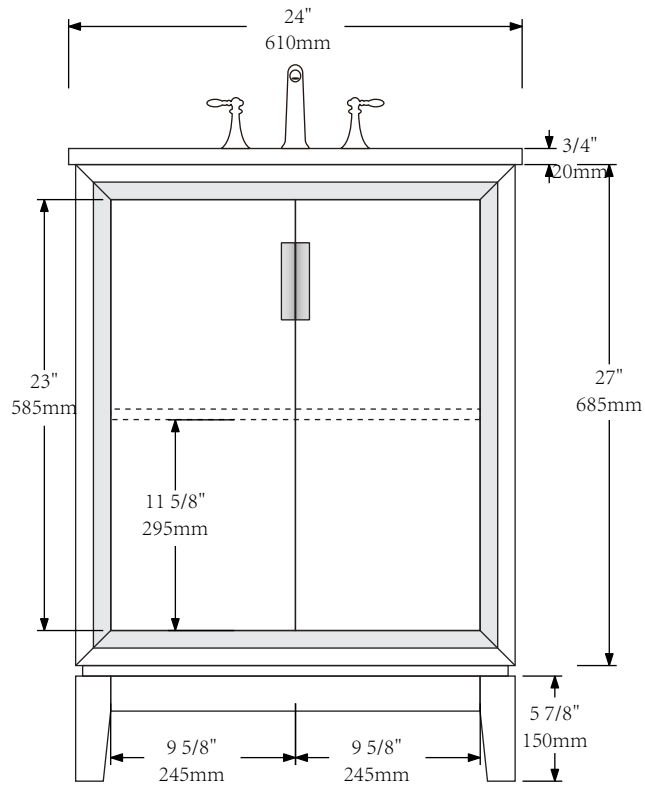

MODEL: ELIZABETH24

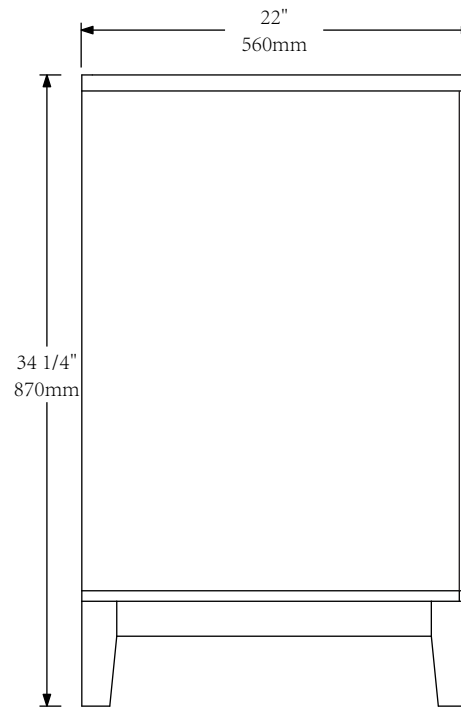

FRONT VIEW



SIDE VIEW

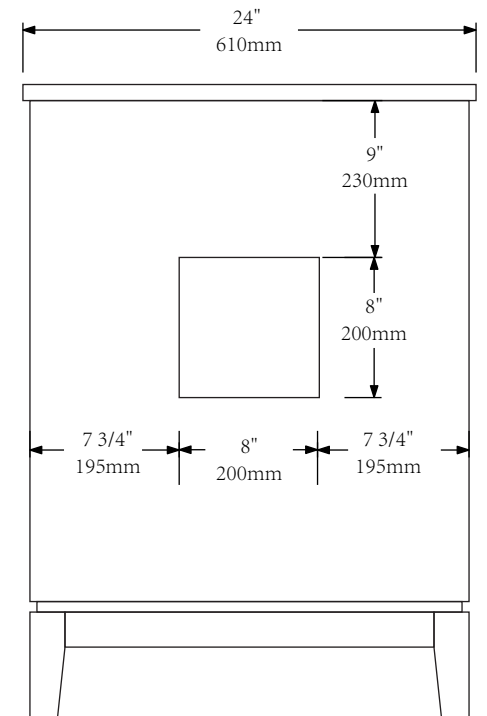

BACK VIEW



**MODEL: ELIZABETH24**

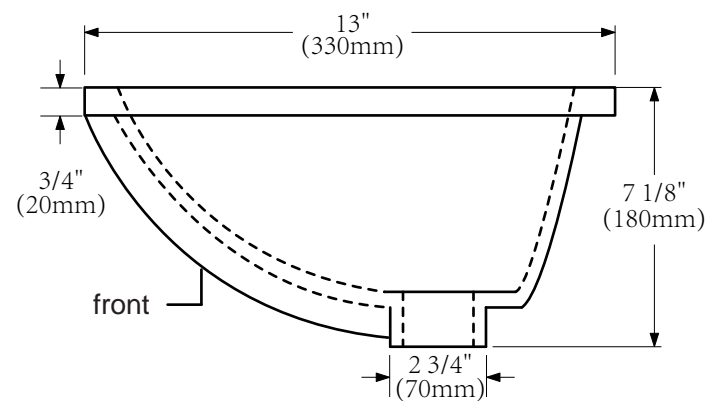
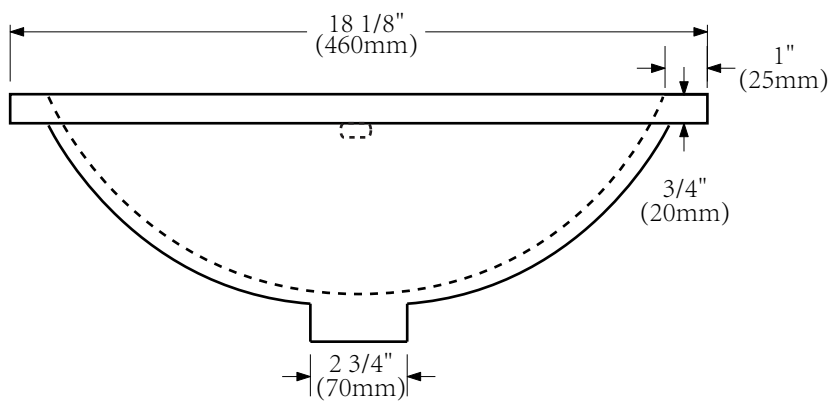
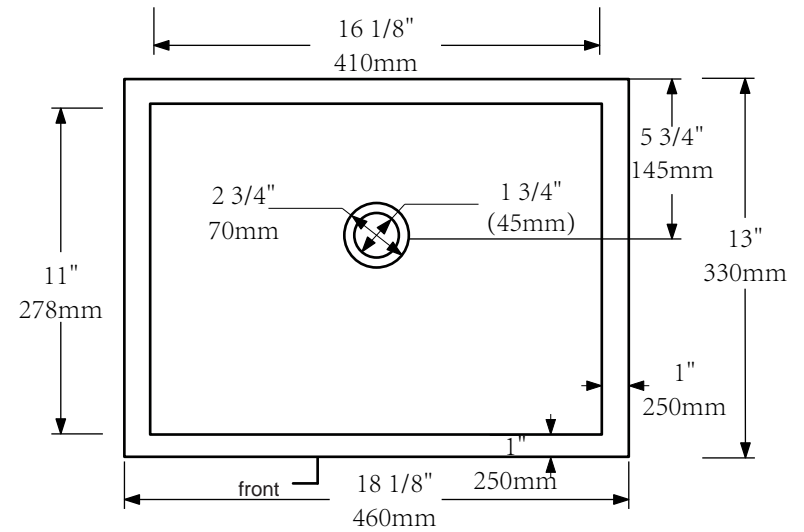
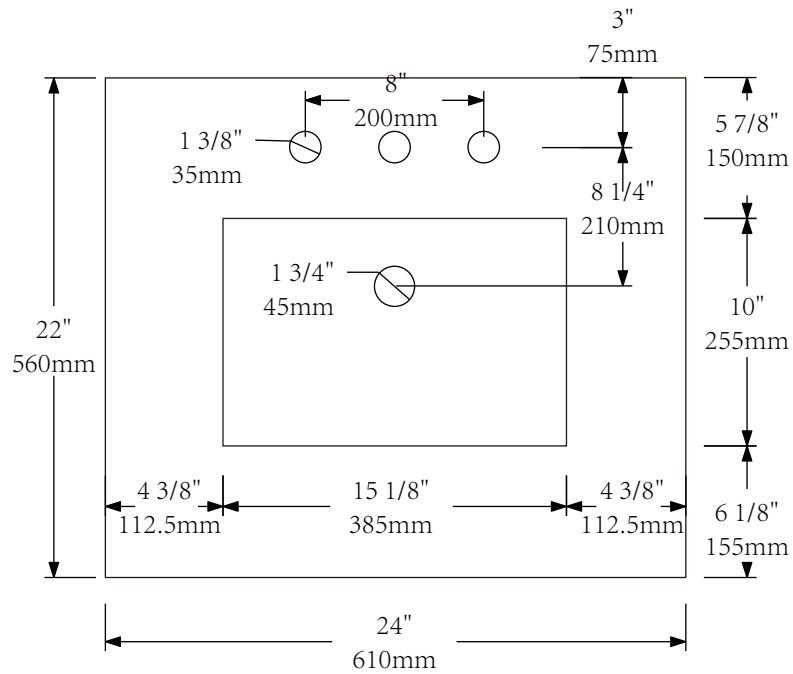



MODEL: F2-0012

