

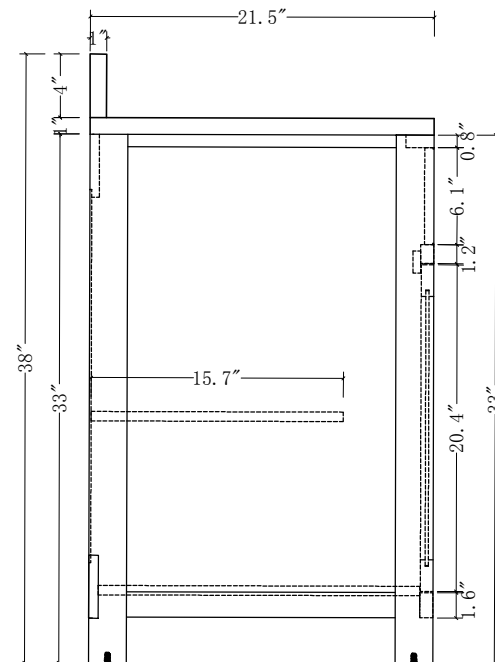

MODEL: MADISON30

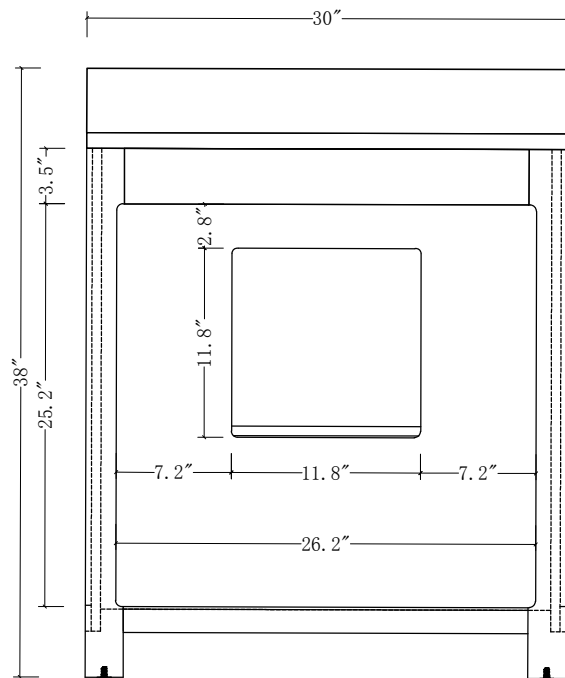

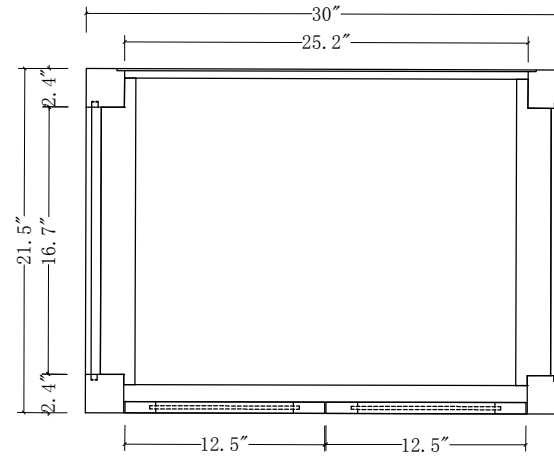
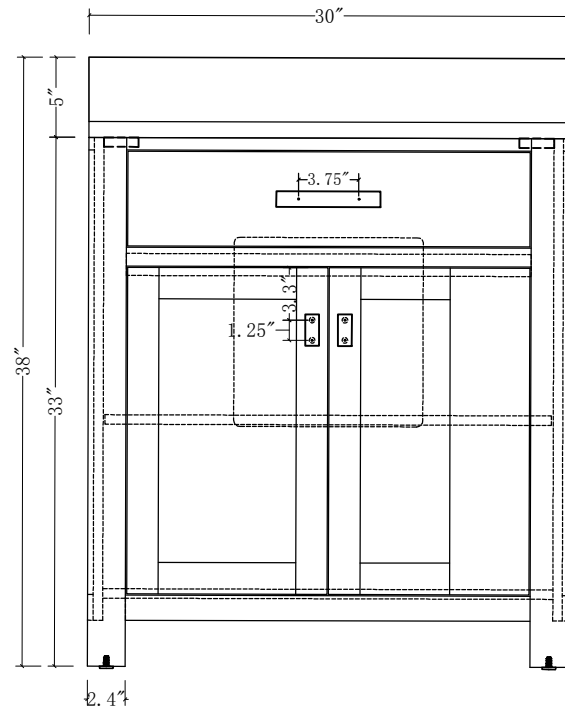

MODEL: MADISON30

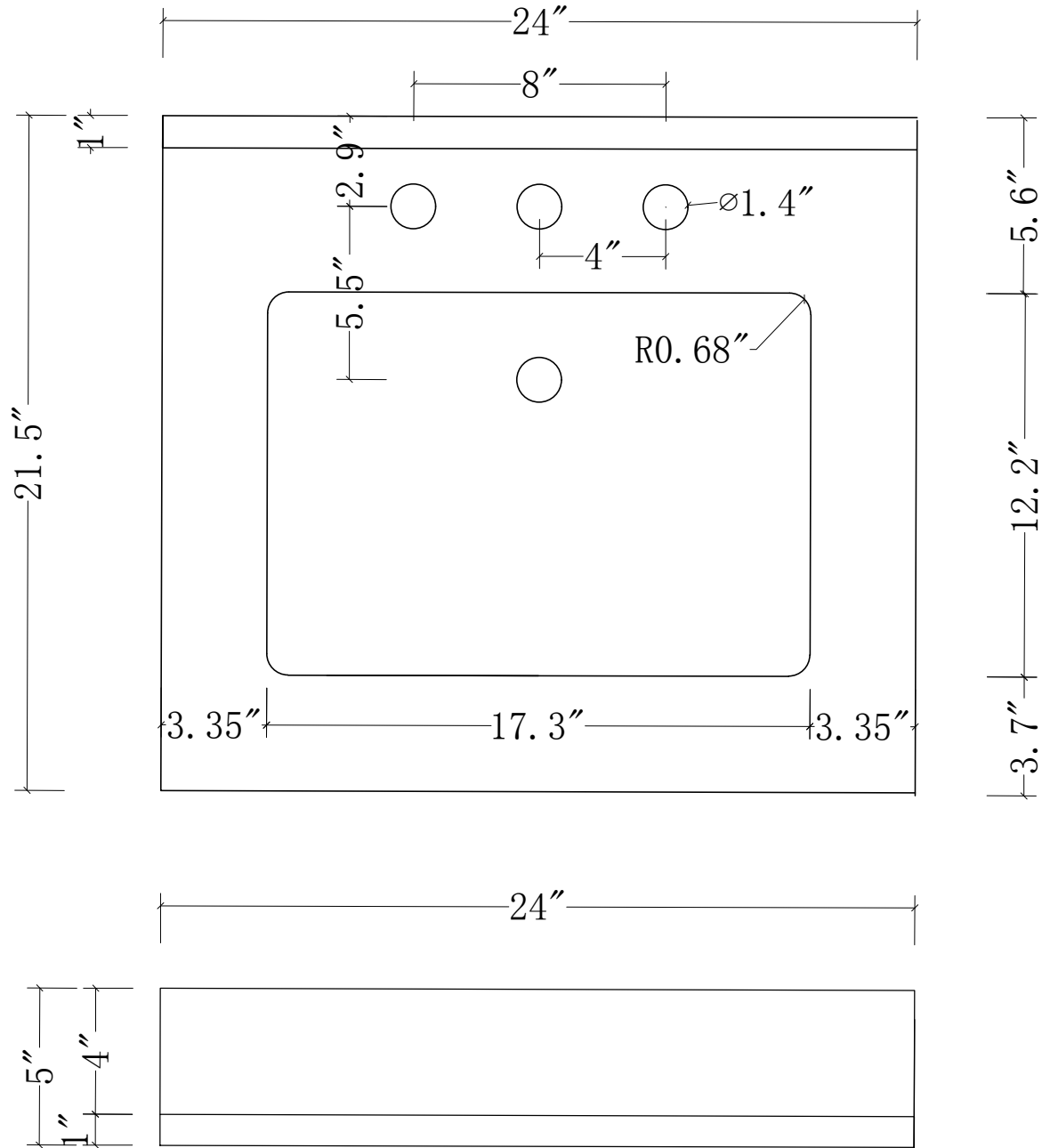



MODEL: MADISON30

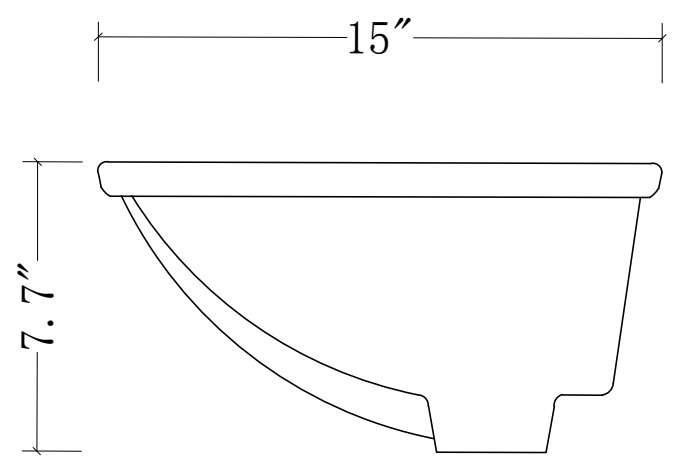
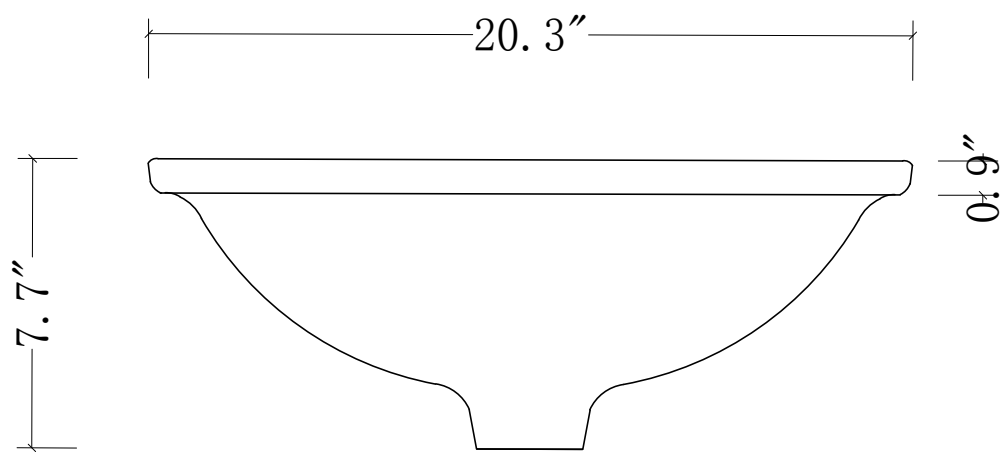
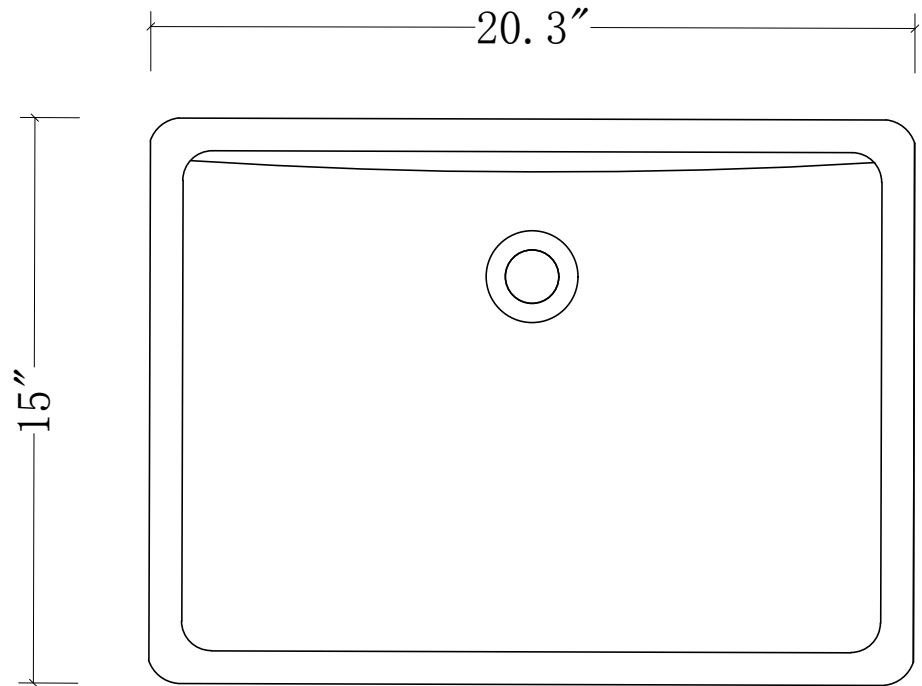



MODEL: F2-0013

