

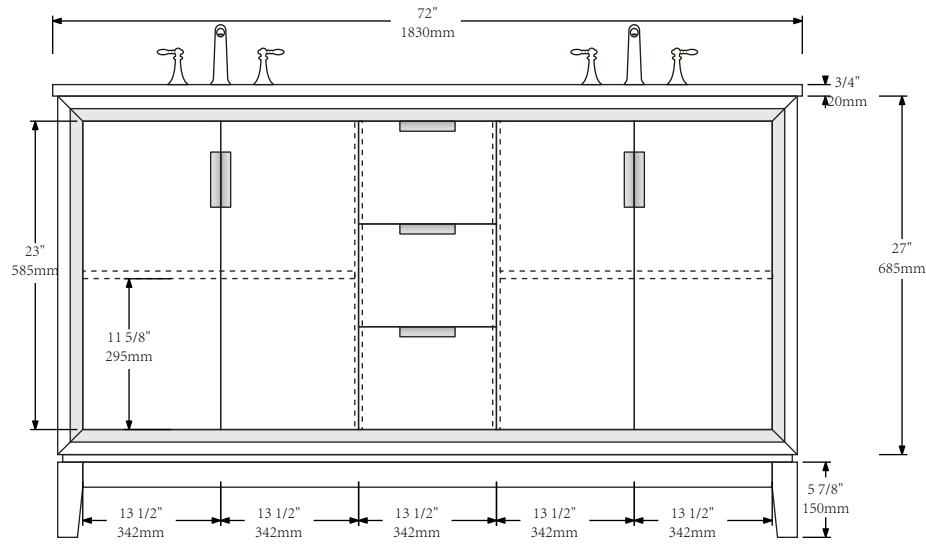

MODEL: ELIZABETH72

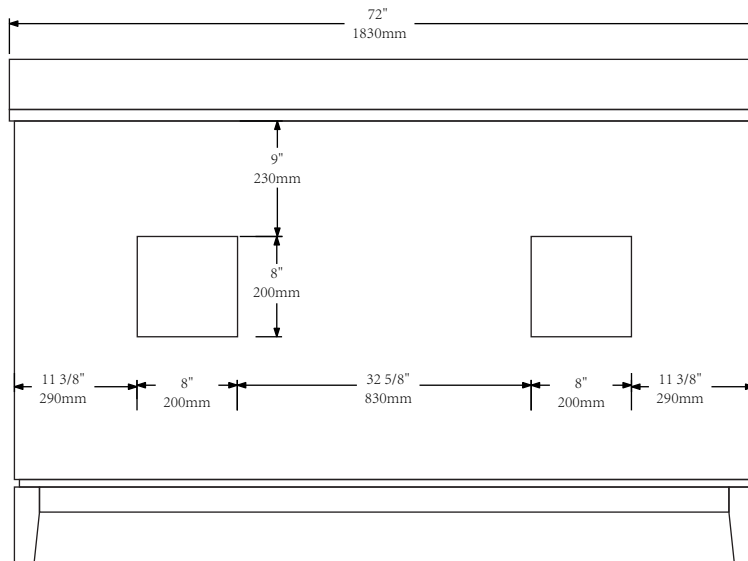

FRONT VIEW



BACK VIEW

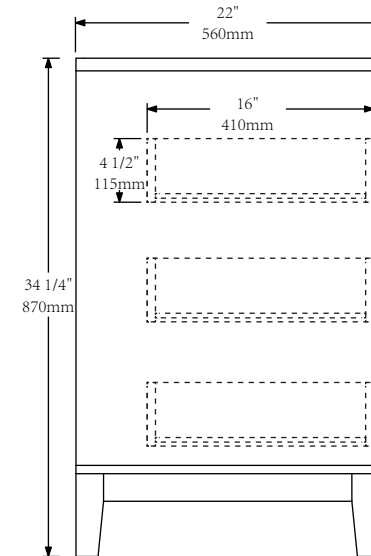

SIDE VIEW



MODEL: ELIZABETH72

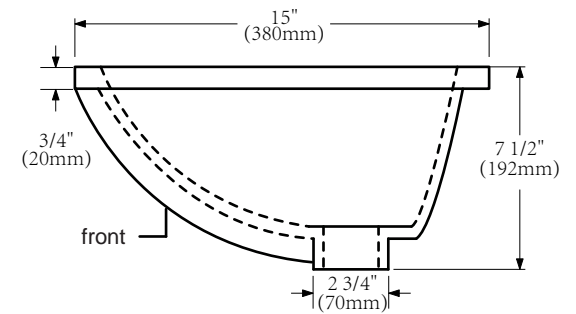
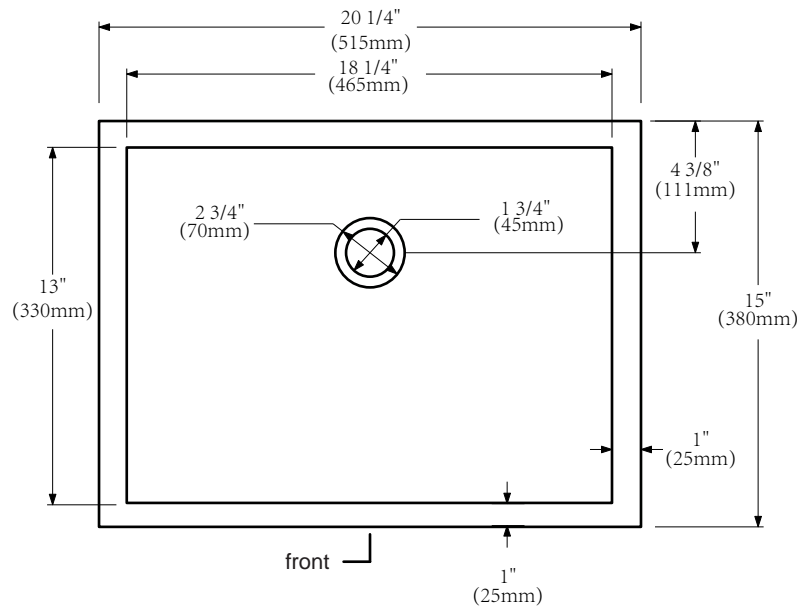
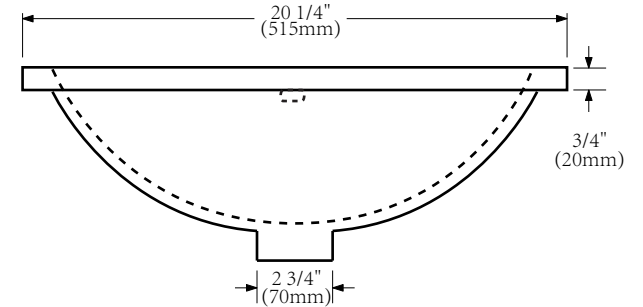
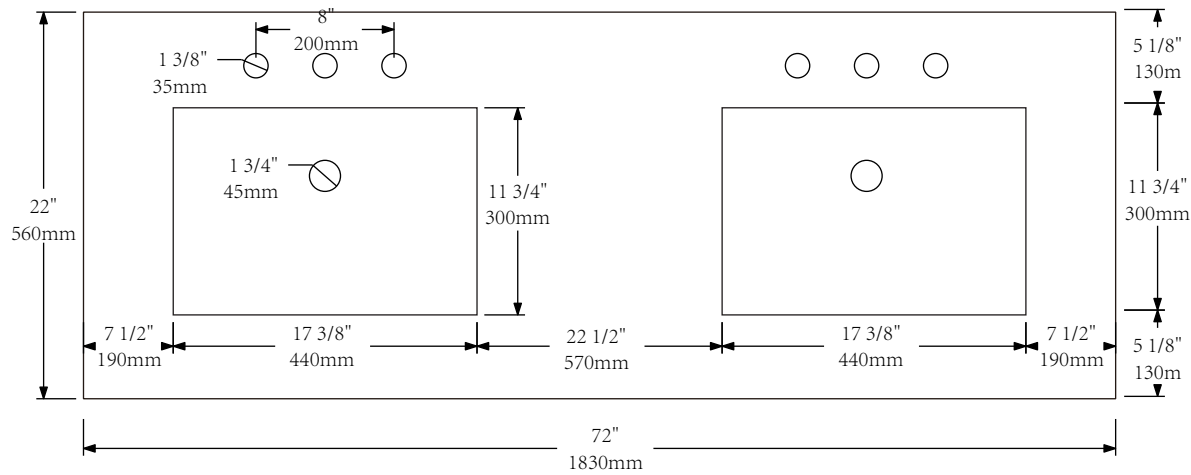



MODEL: F2-0013

