

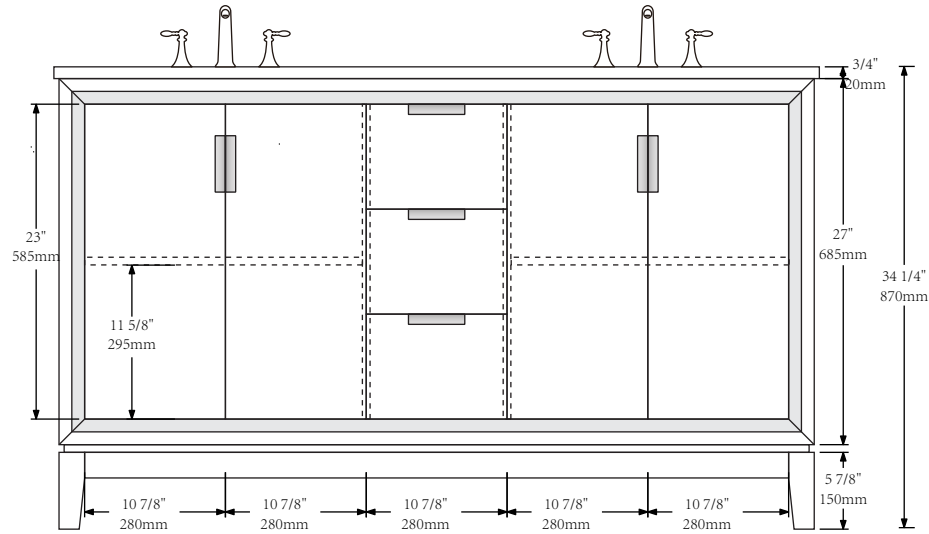

MODEL: ELIZABETH60

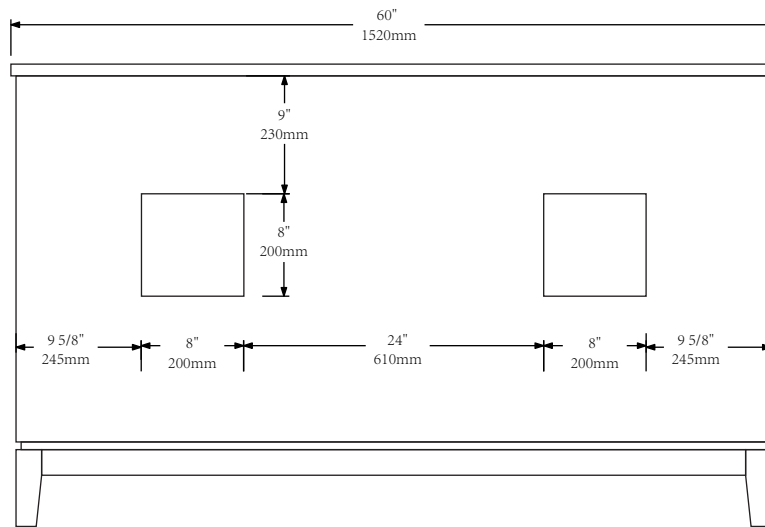

FRONT VIEW



BACK VIEW

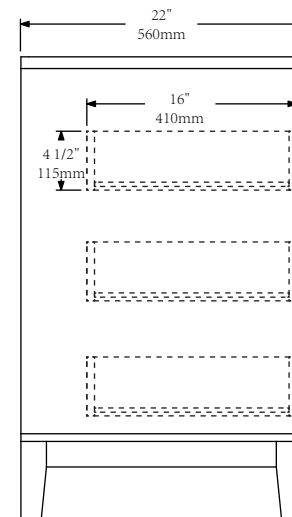

SIDE VIEW



MODEL: ELIZABETH60

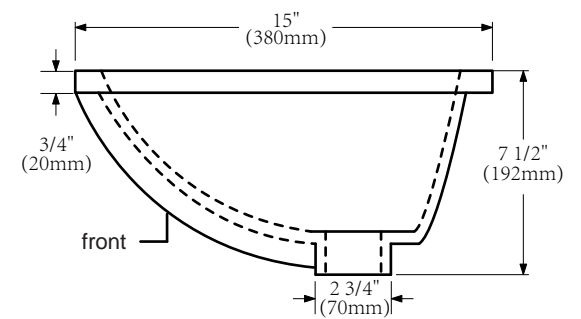
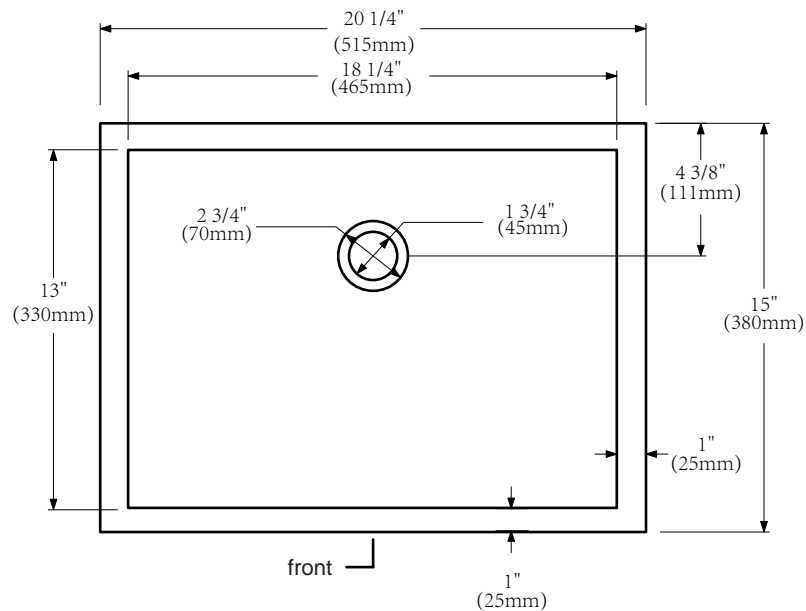
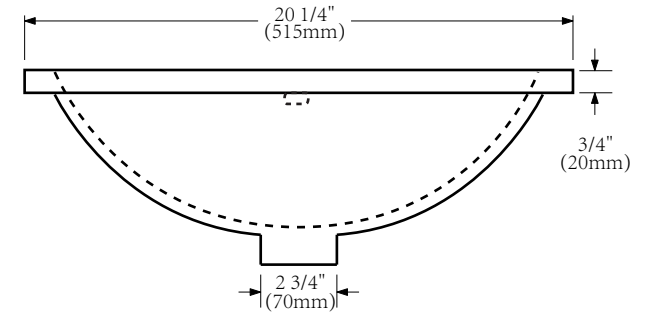
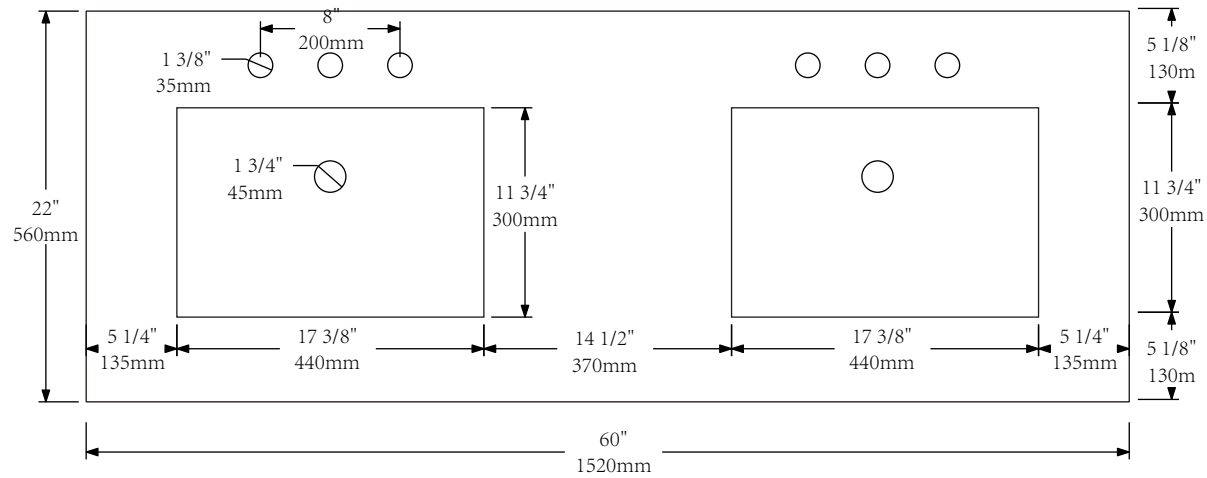



MODEL: F2-0013

