

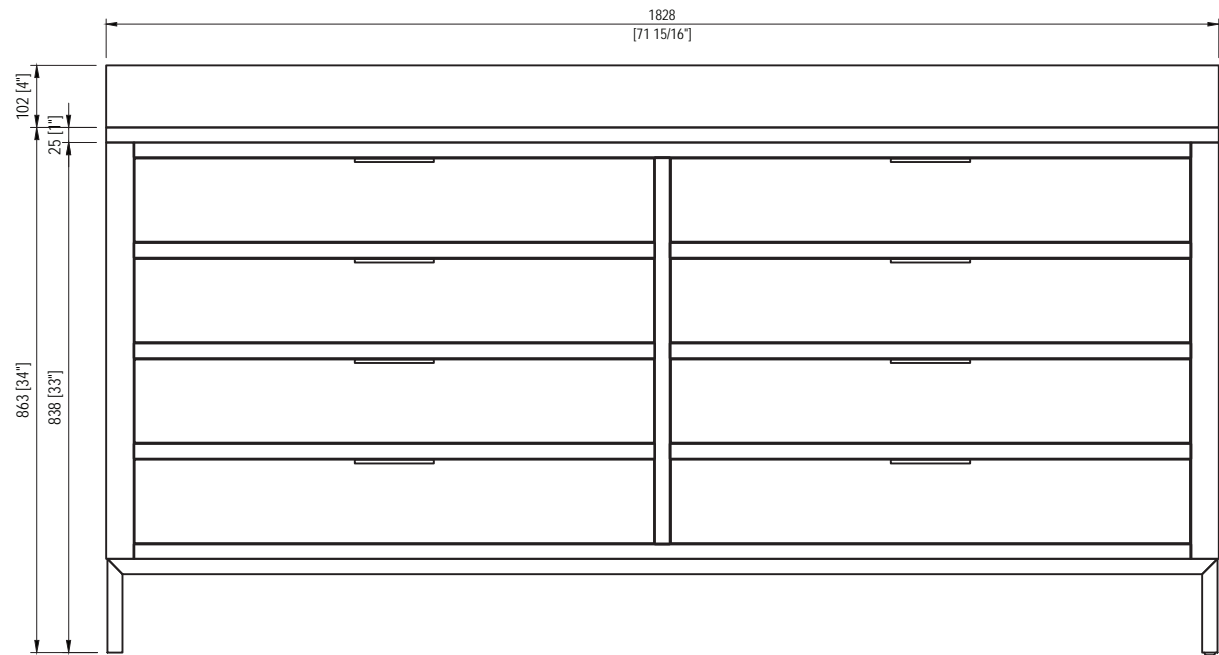

MODEL: BRISTOL 72

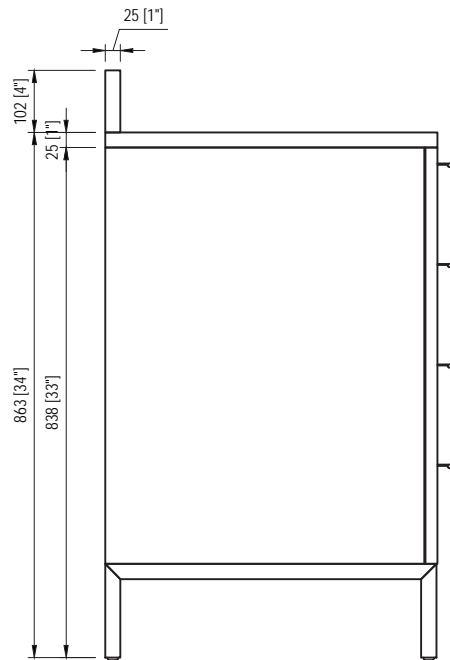

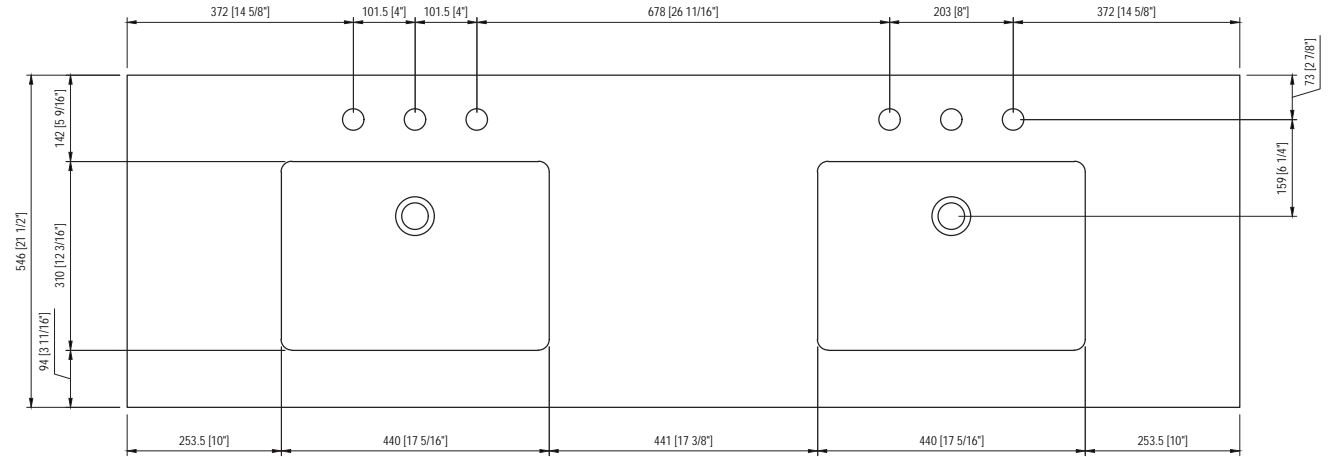

MODEL: BRISTOL 72

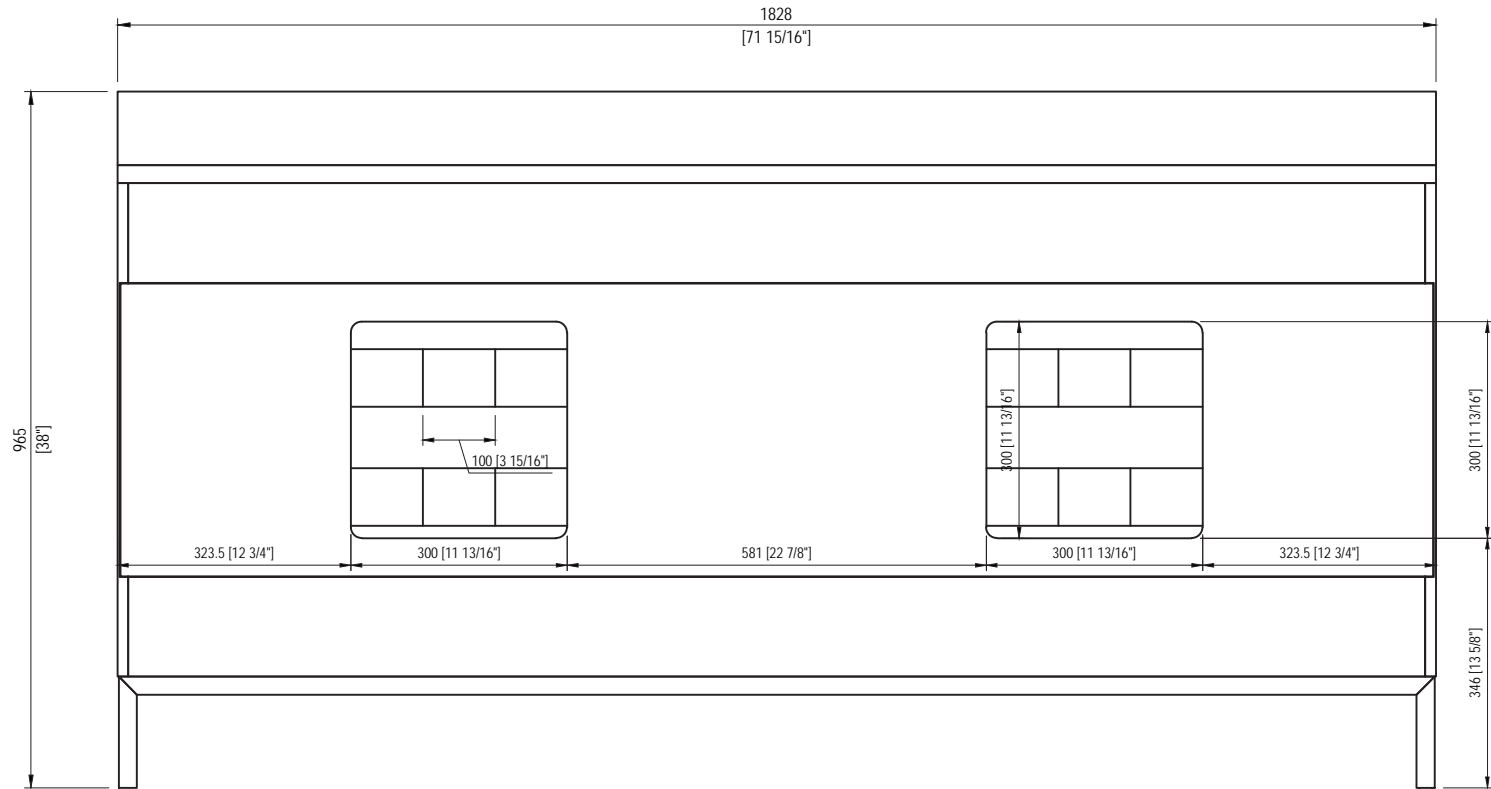



MODEL: BRISTOL 72

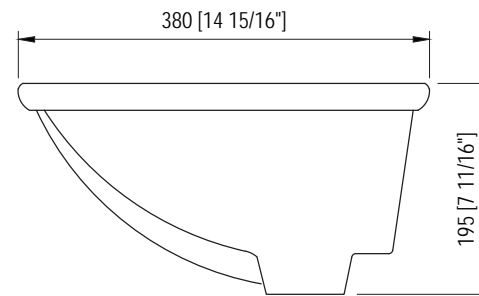
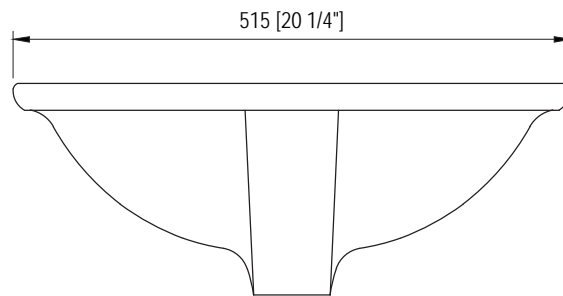
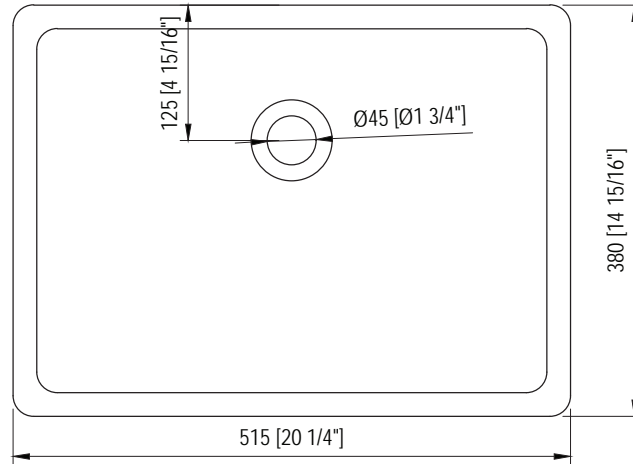



MODEL: BRISTOL 72

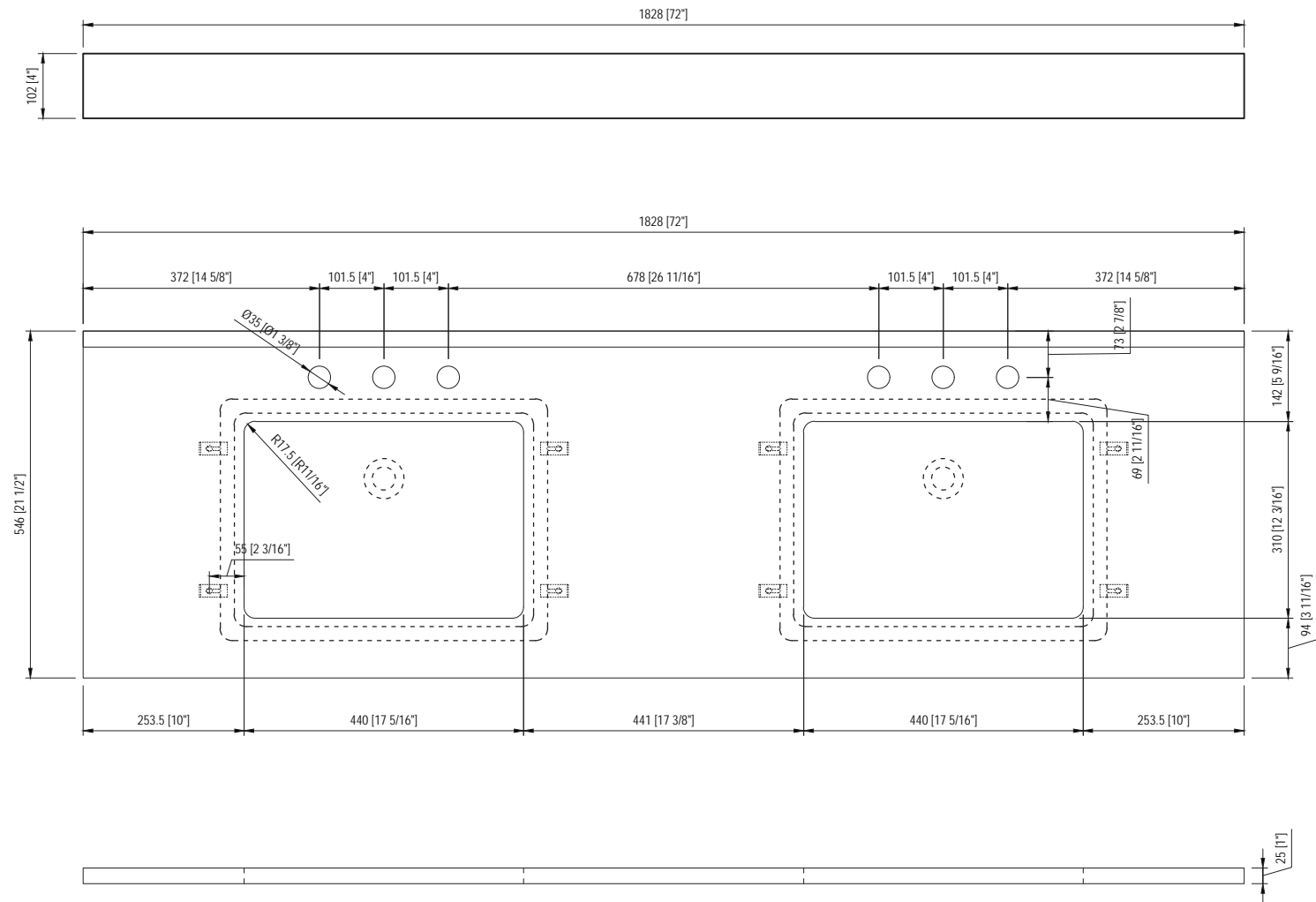



MODEL: BRISTOL 72

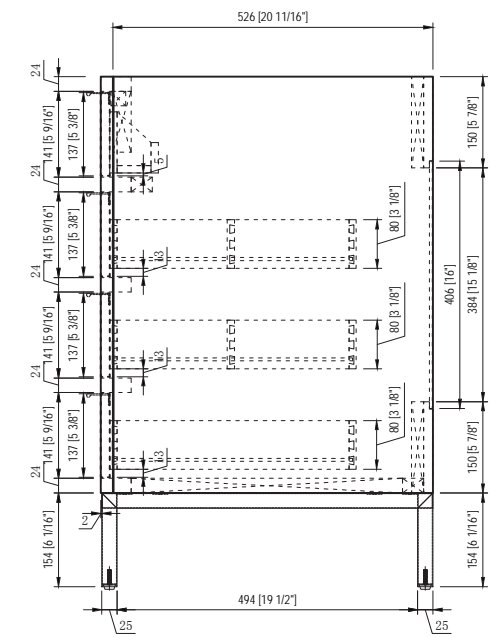
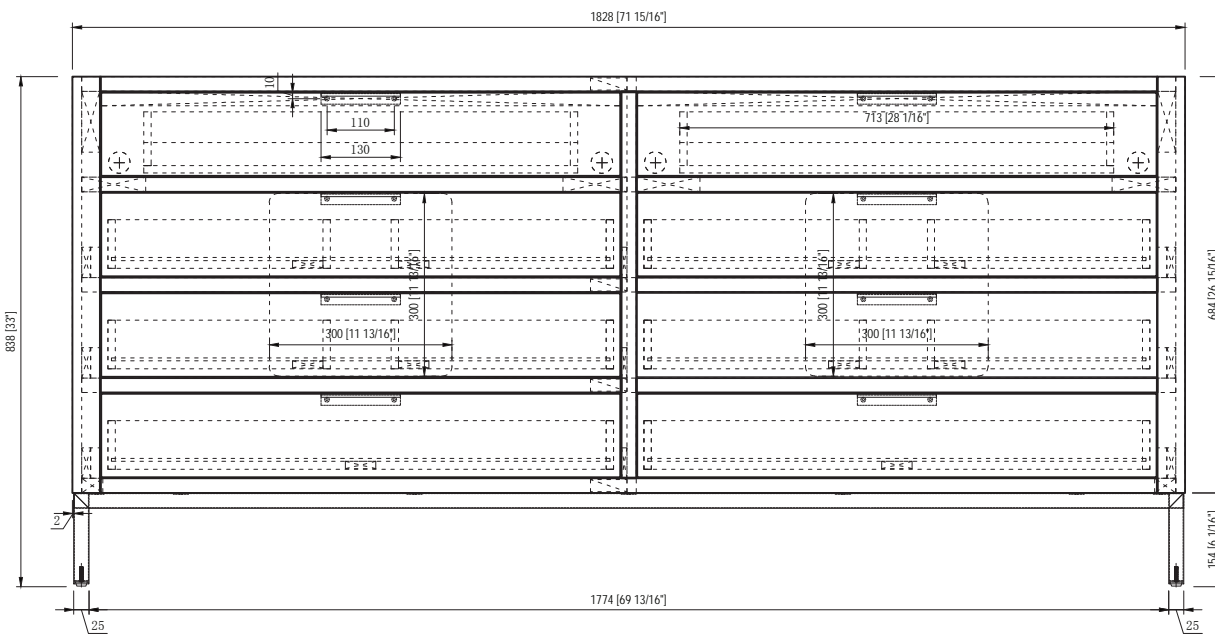
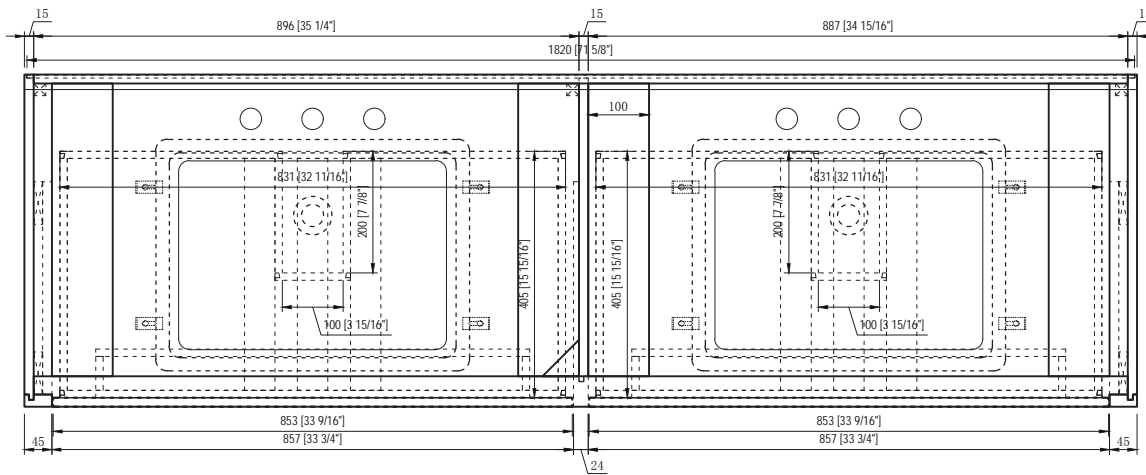



MODEL: RET-M-2136

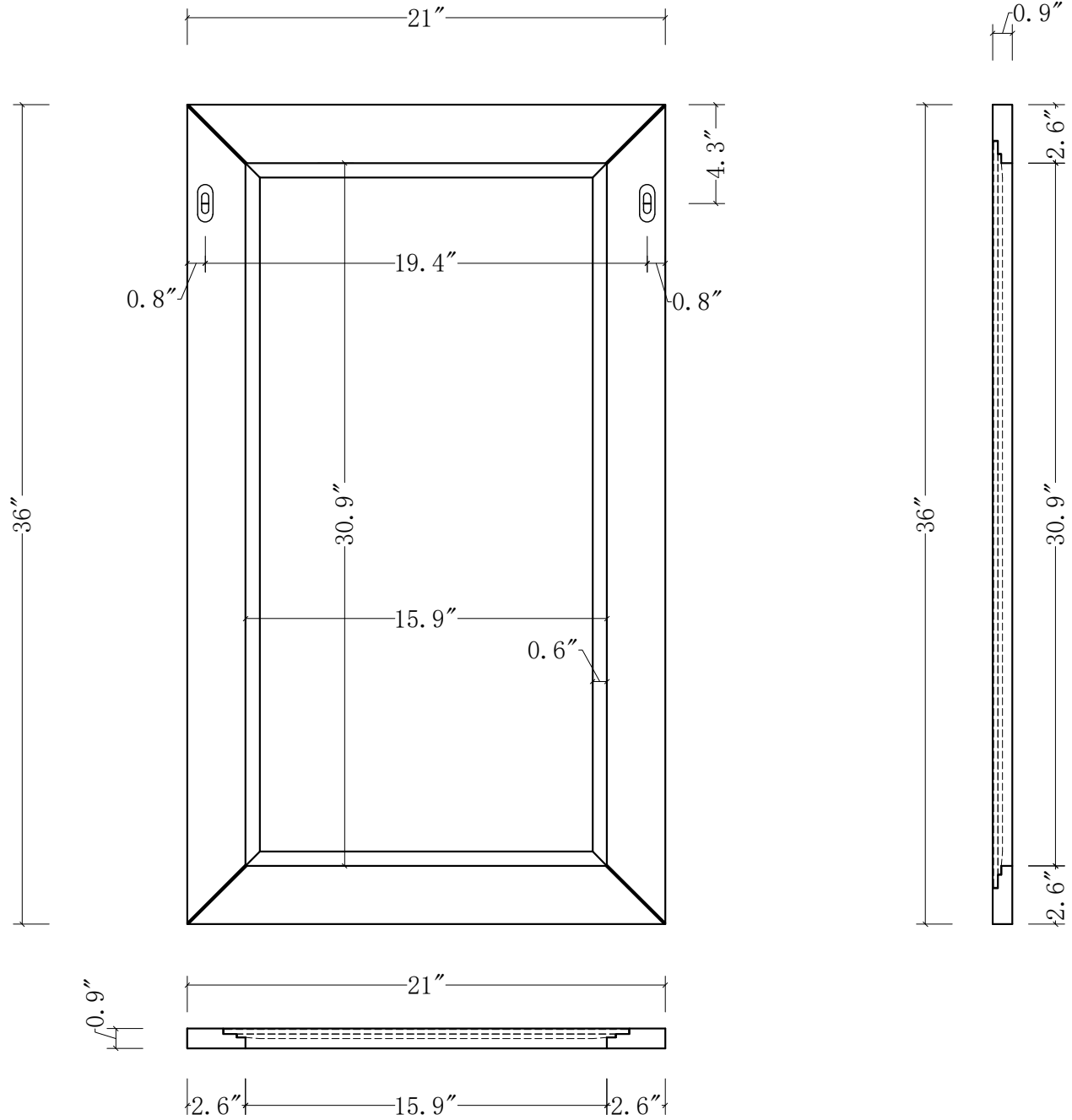



MODEL: F2-0012

