

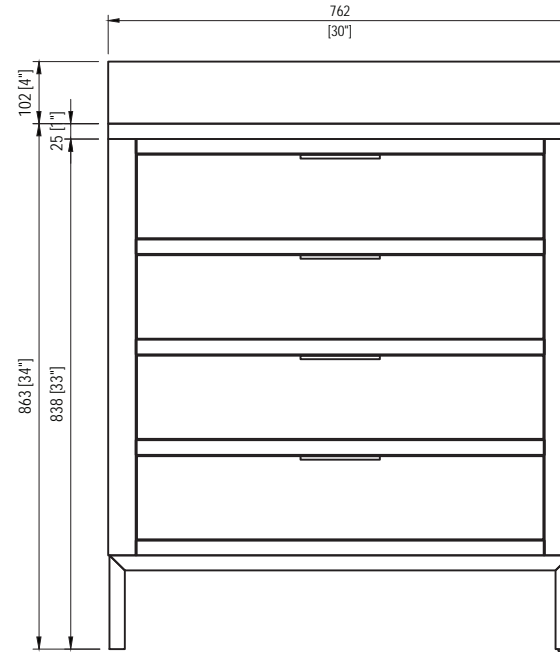

MODEL: BRISTOL 30

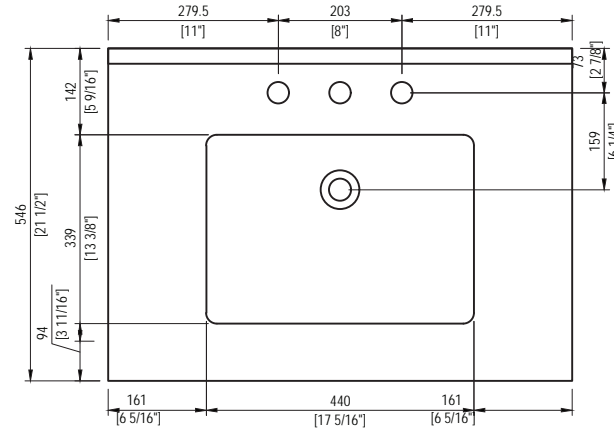

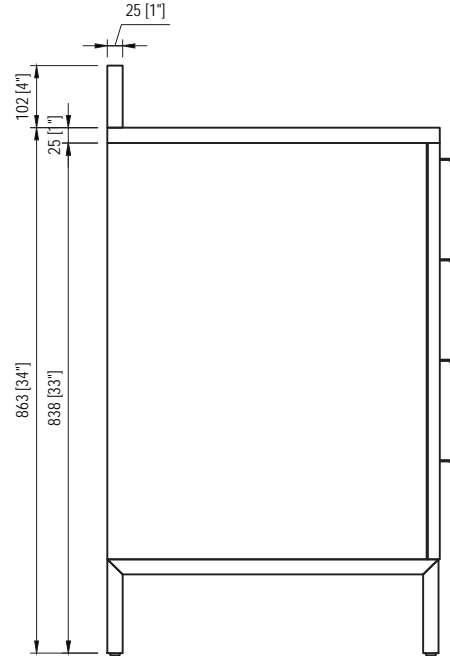

MODEL: BRISTOL 30

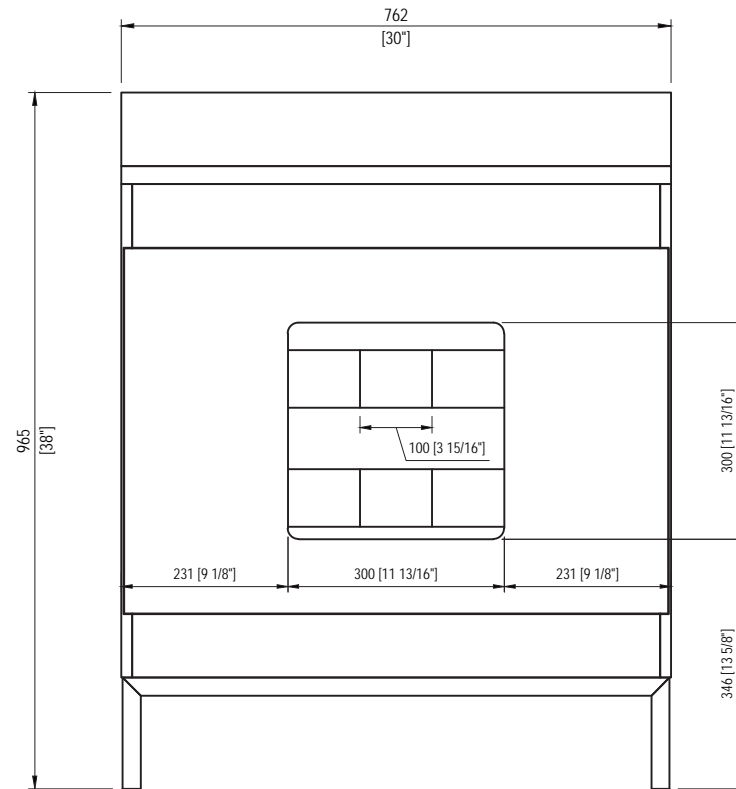



MODEL: BRISTOL 30

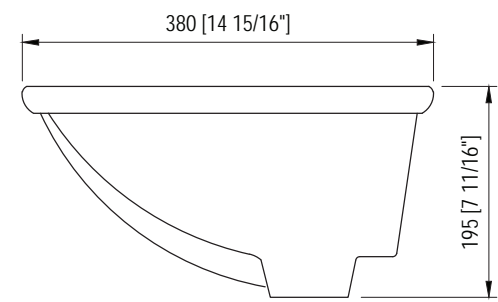
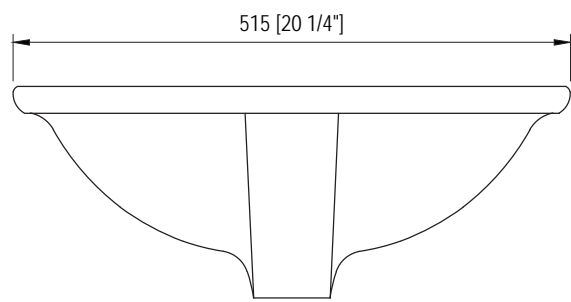
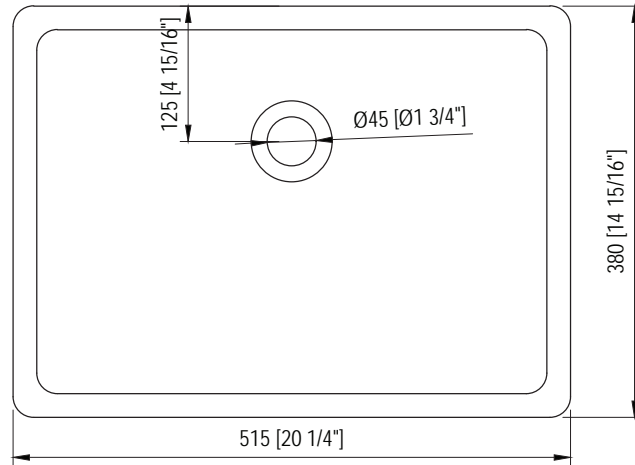



MODEL: BRISTOL 30

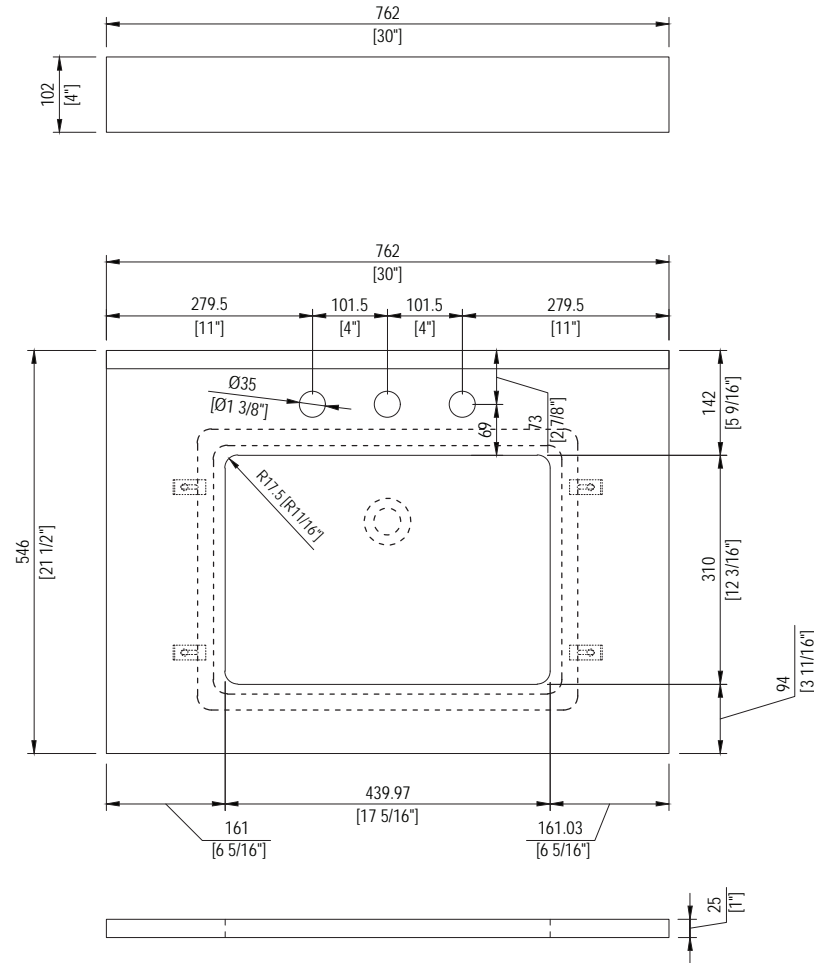



MODEL: BRISTOL 30

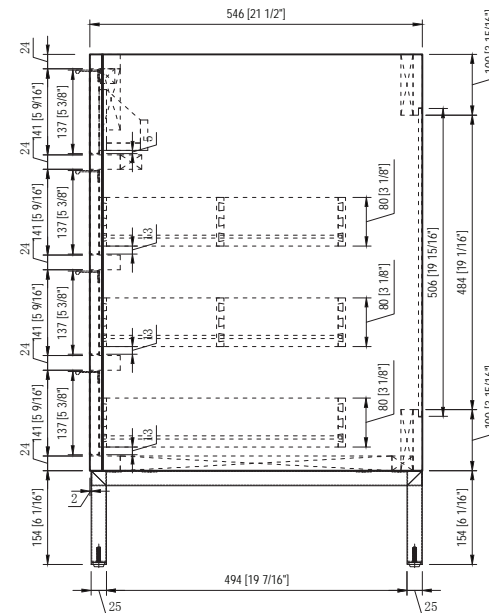
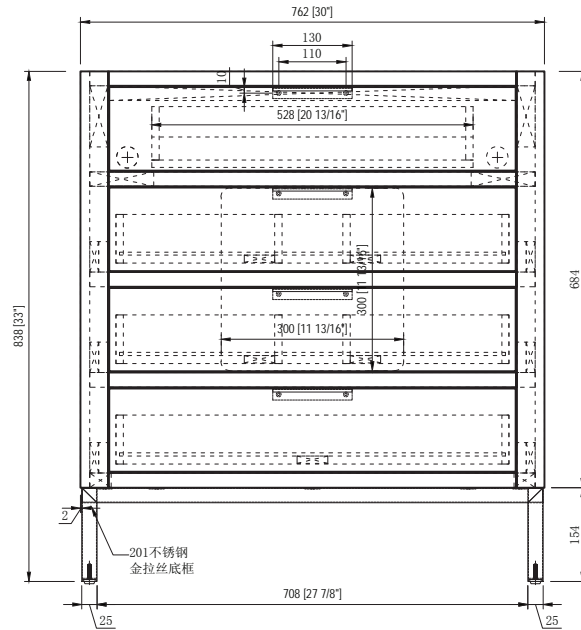
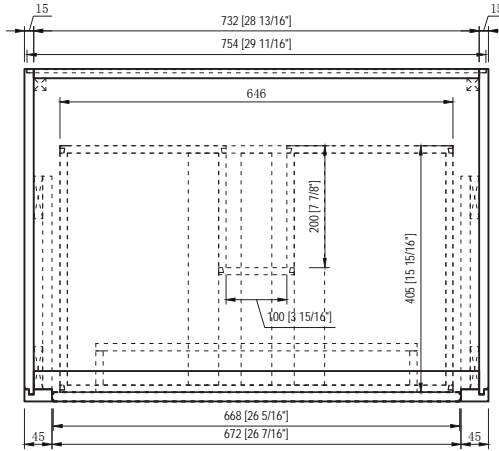



MODEL: F2-0012

