

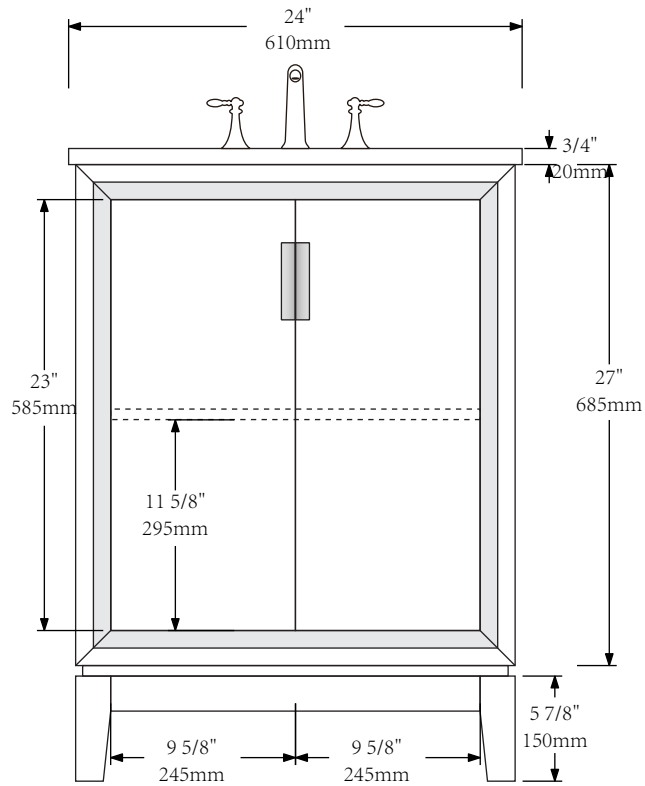

MODEL: ELIZABETH24

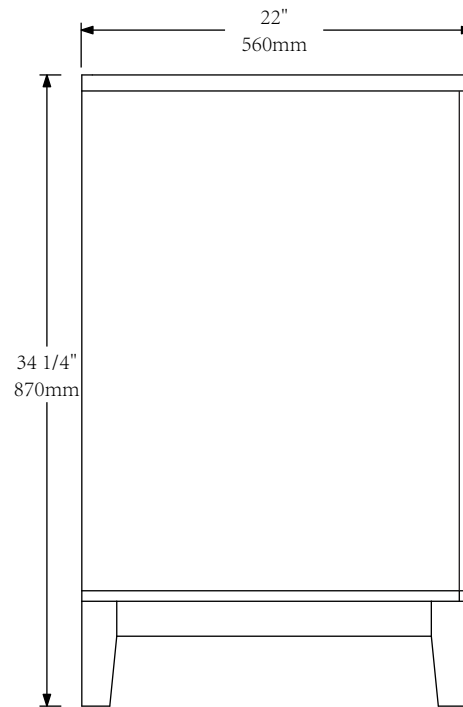

FRONT VIEW



SIDE VIEW

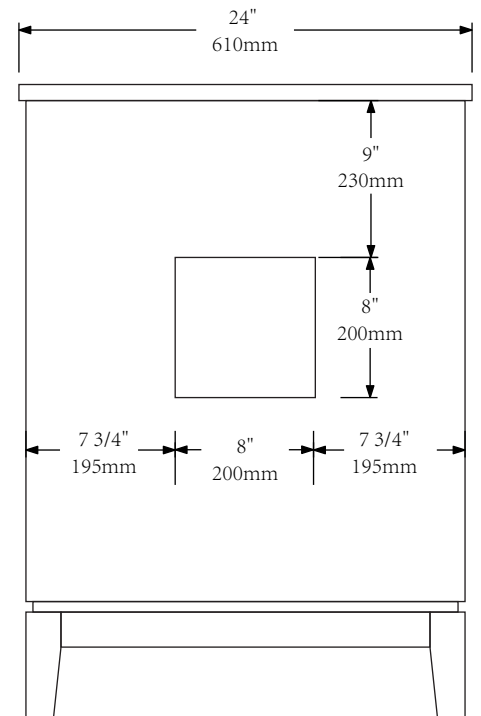

BACK VIEW



MODEL: ELIZABETH24

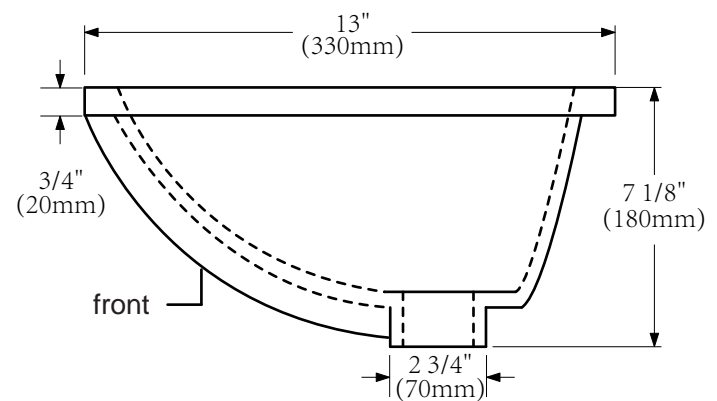
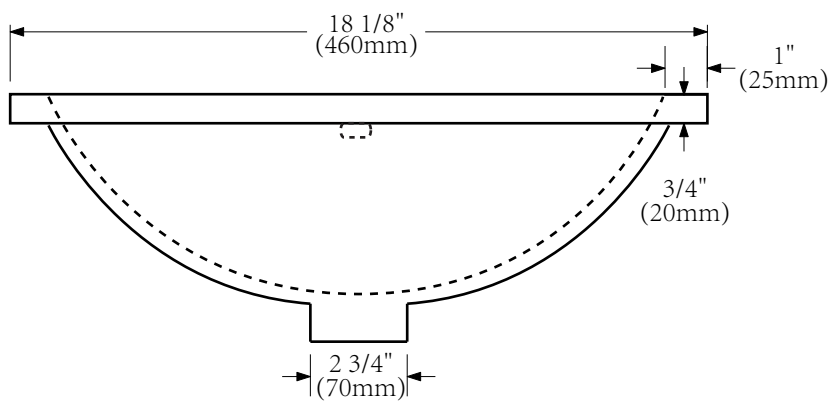
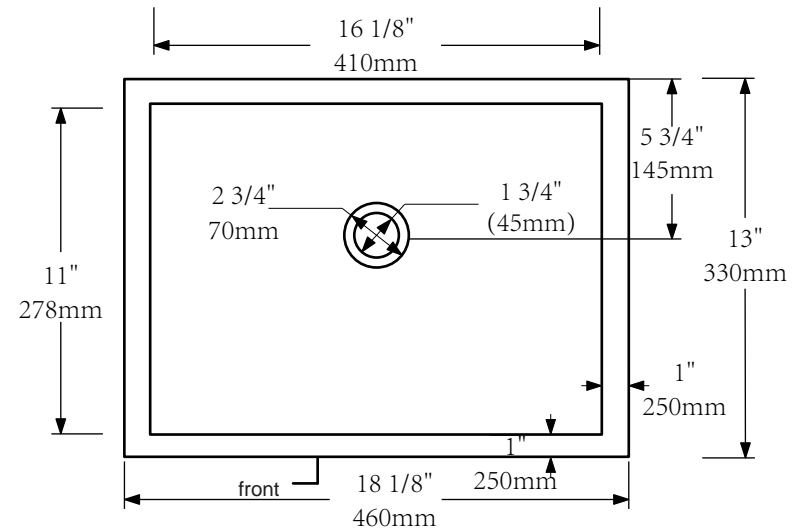
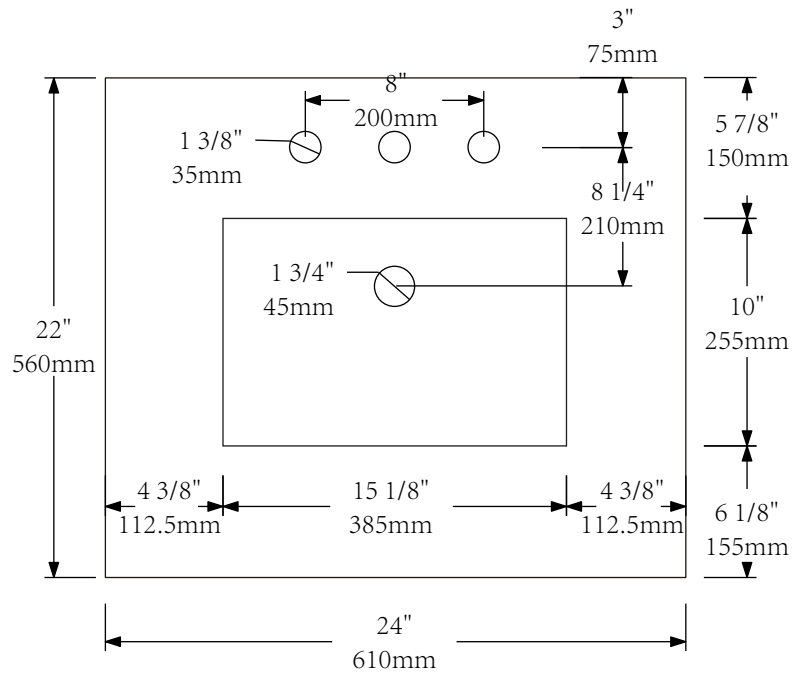



MODEL: RET-M-2136

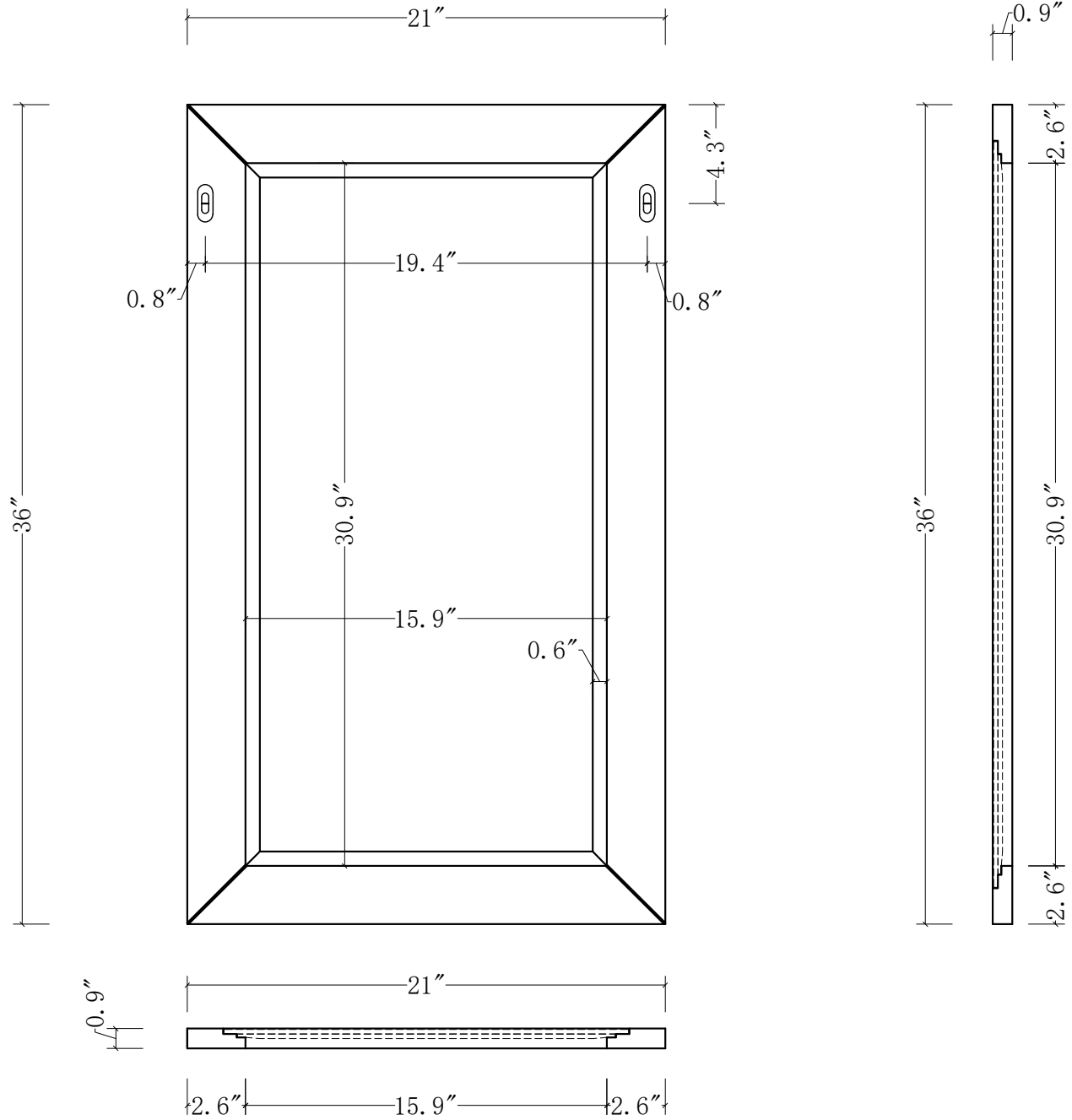



MODEL: F2-0012

