

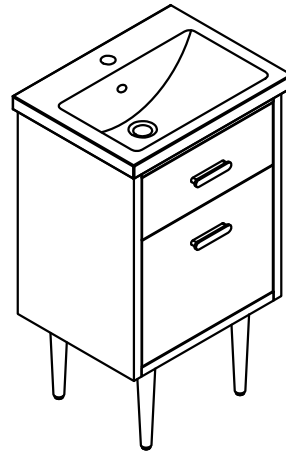

MODEL: BRANDY 20

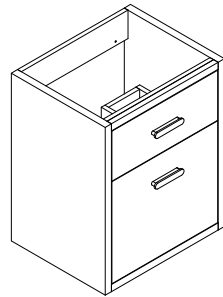

Parts List



A x 1
Cabinet



B x 4
Legs

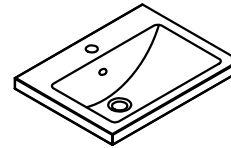

C x 1
Ceramic sink 20"

Hardware



(M8*40mm)
(H1) x 2



(M4*55mm)
(H2) x 2

It is highly recommended to install the plumbing before the vanity



MODEL: BRANDY 20

Step 1

- Put the cabinet upside down, then take 1 leg and screw it down clockwise until it is unable to screw any further. Do the same for the other 3 legs. (All legs are the same, there are levelers on the bottom of each leg which can adjust the height of the cabinet to level the cabinet when installed.

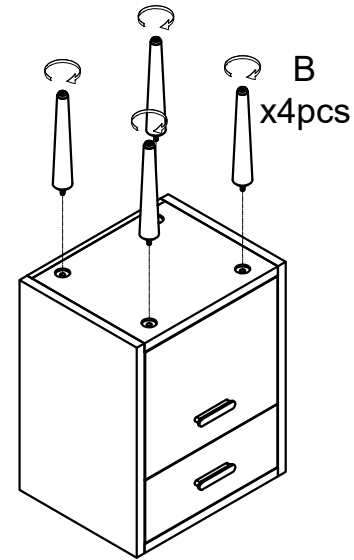

Step 2

- Flip the cabinet and drill 2 holes on the backboard. Position the cabinet and mark the two holes on the wall. Move the cabinet away and drill 2 holes into the wall. Knock in H1 (2pcs) into the wall. Reposition the cabinet to the wall and screw H2 (2pcs) through the cabinet hole to secure it.

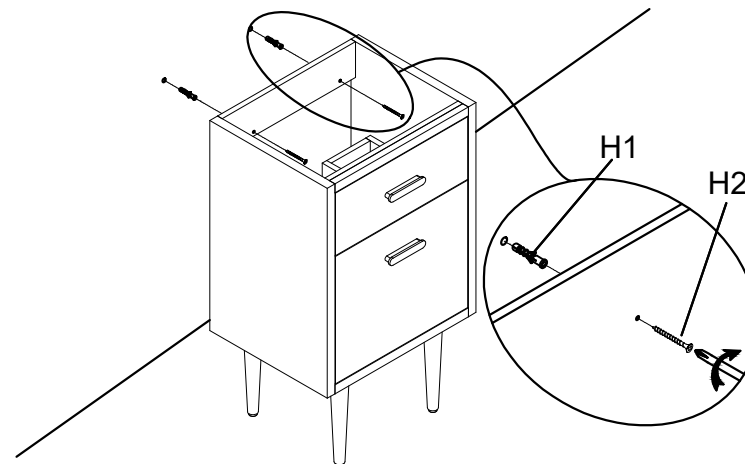



MODEL: BRANDY 20

Step 3

- Apply clear silicone (not included) on the top of the cabinet on 4 sides, then attach the ceramic sink.
- Quickly adjust the sink accordingly, making sure all sides align.
- Wait 24 hours before use.

