

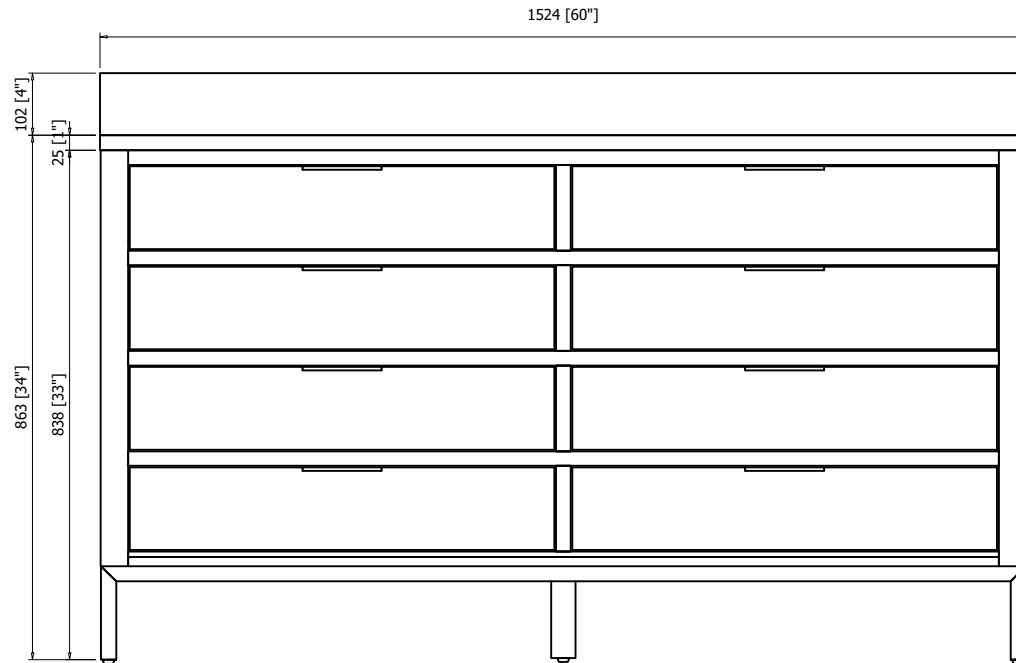

MODEL: BRISTOL 60

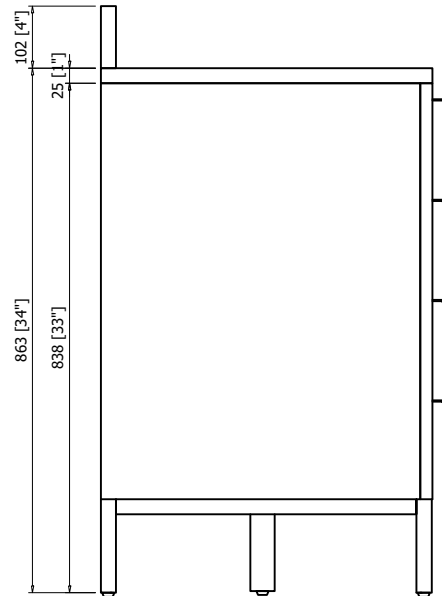

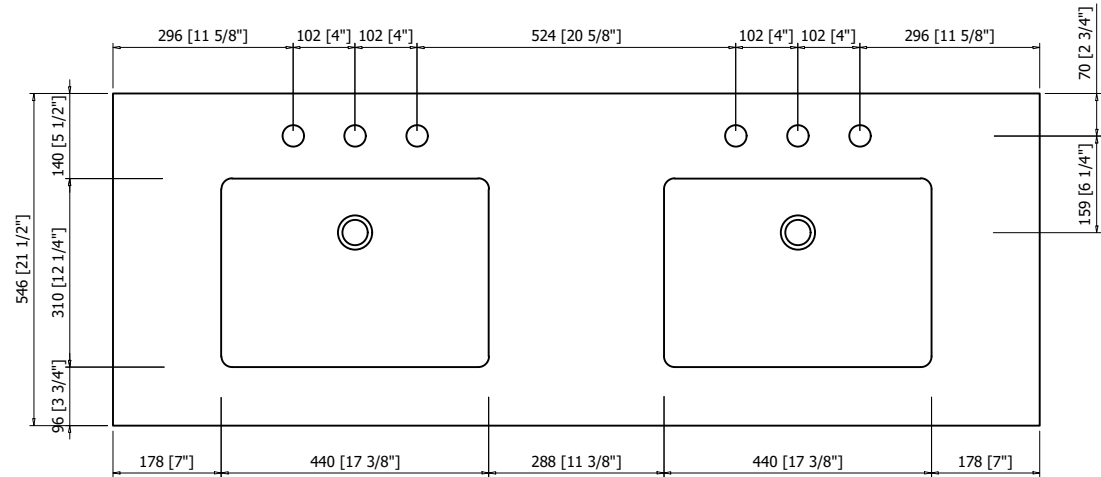

MODEL: BRISTOL 60

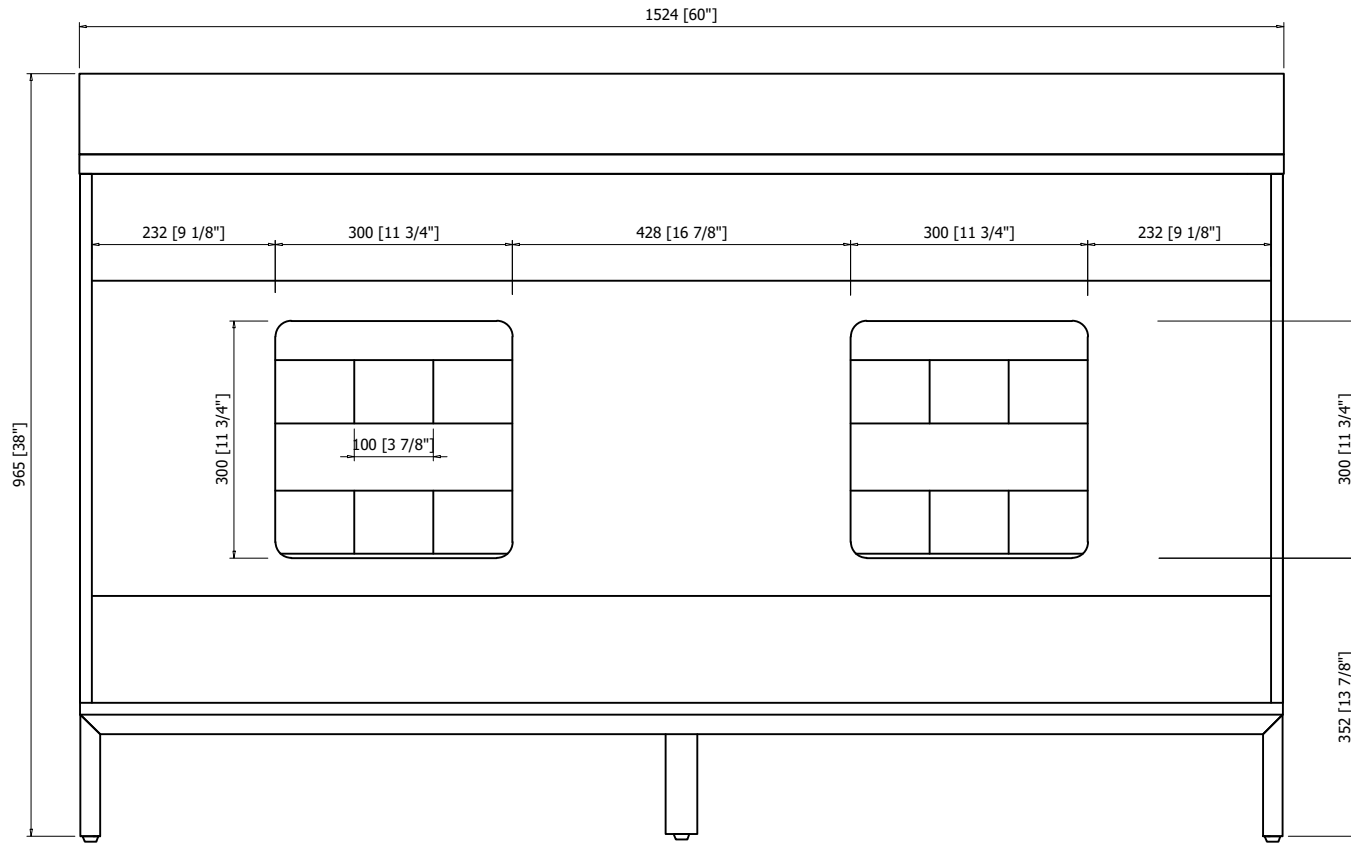



MODEL: BRISTOL 60

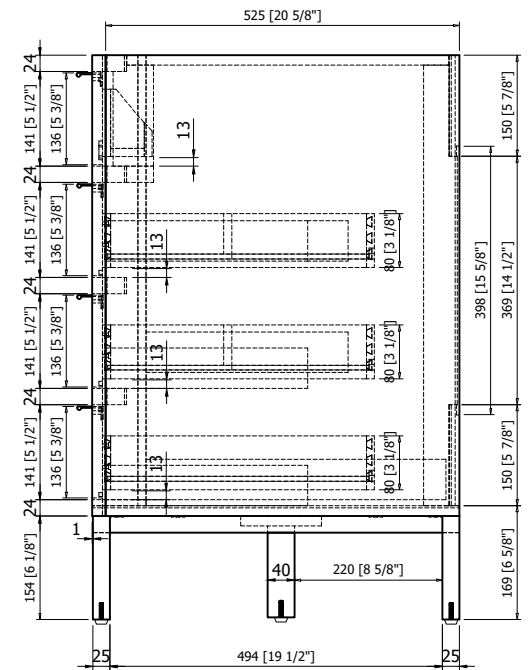
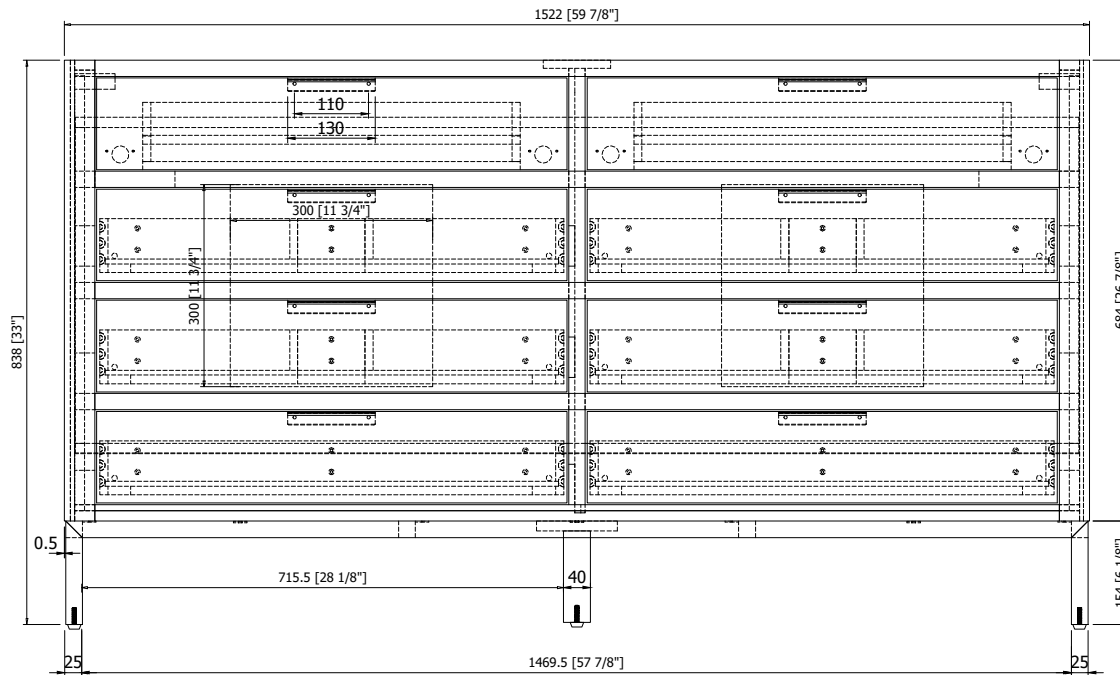
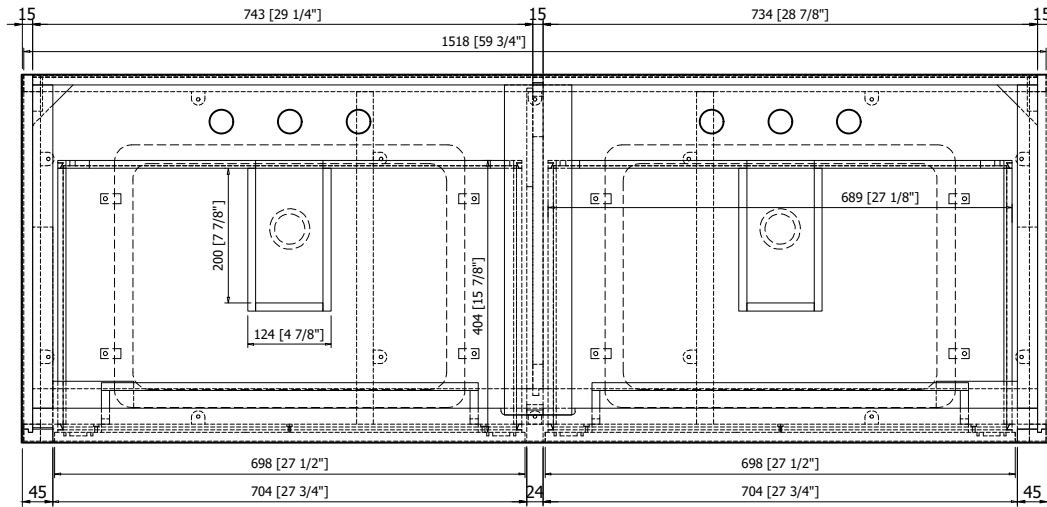



MODEL: BRISTOL 60

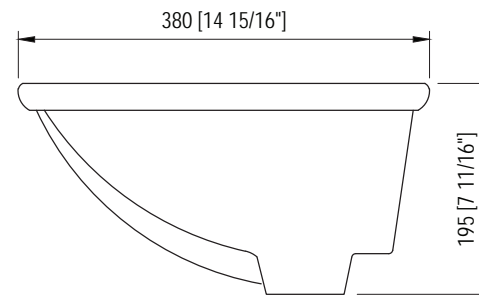
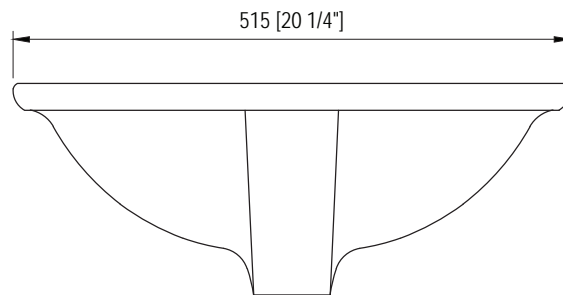
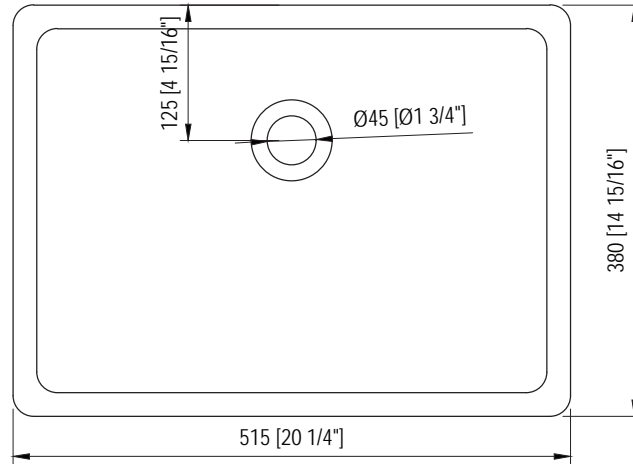



MODEL: BRISTOL 60

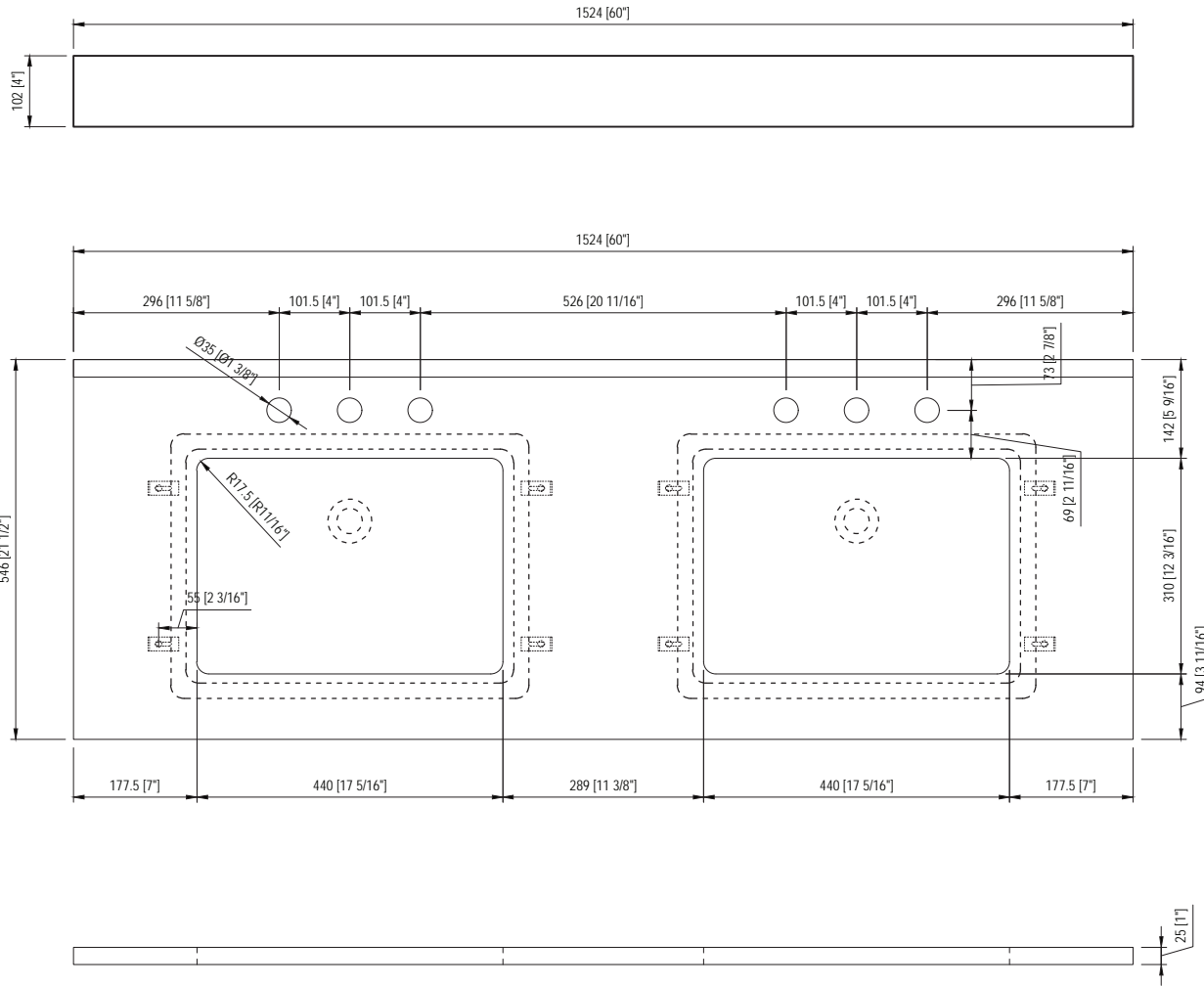



MODEL: RET-M-2136

