

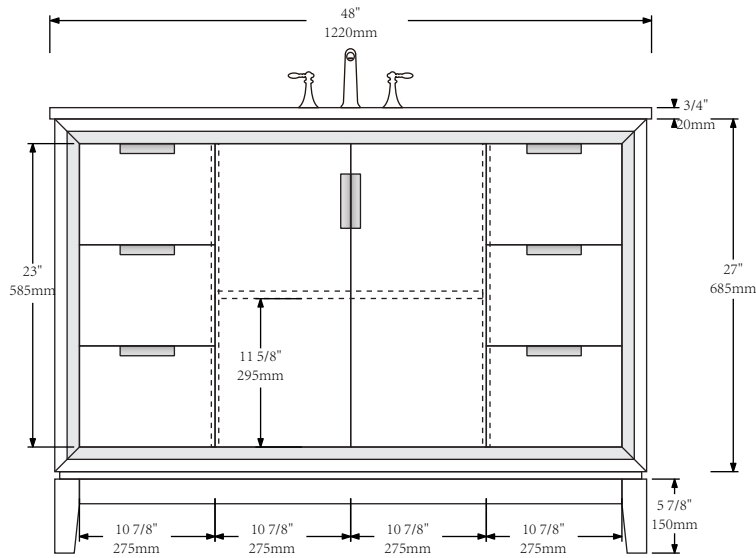

MODEL: ELIZABETH48

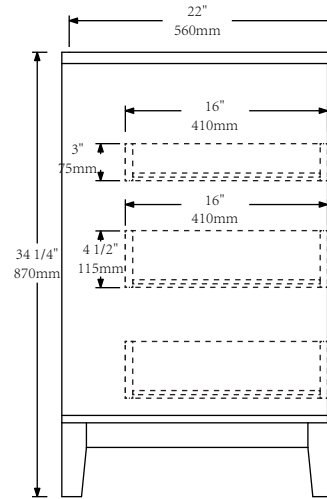

FRONT VIEW



SIDE VIEW

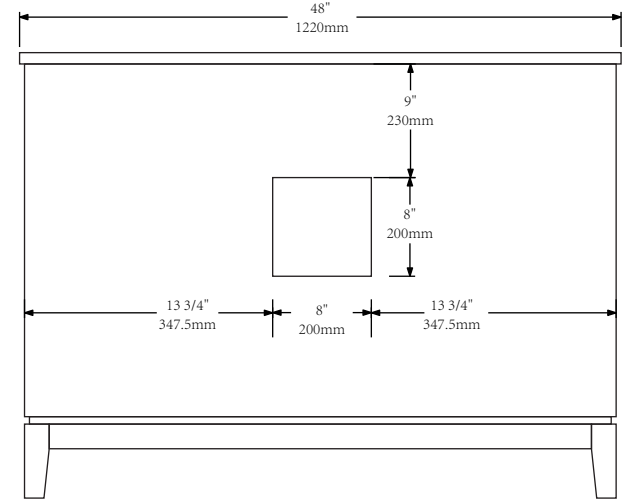

BACK VIEW



MODEL: ELIZABETH48

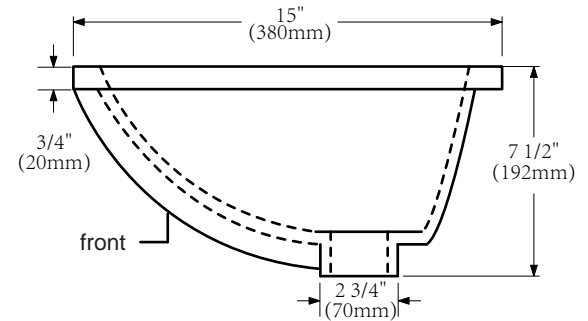
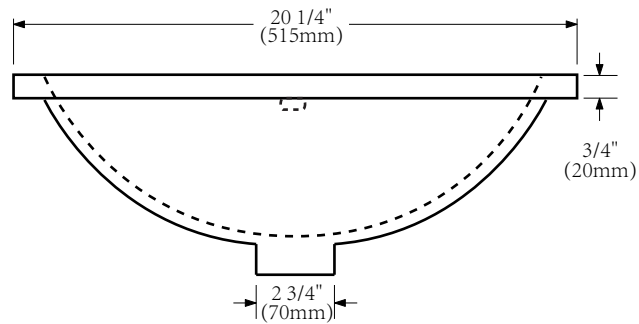
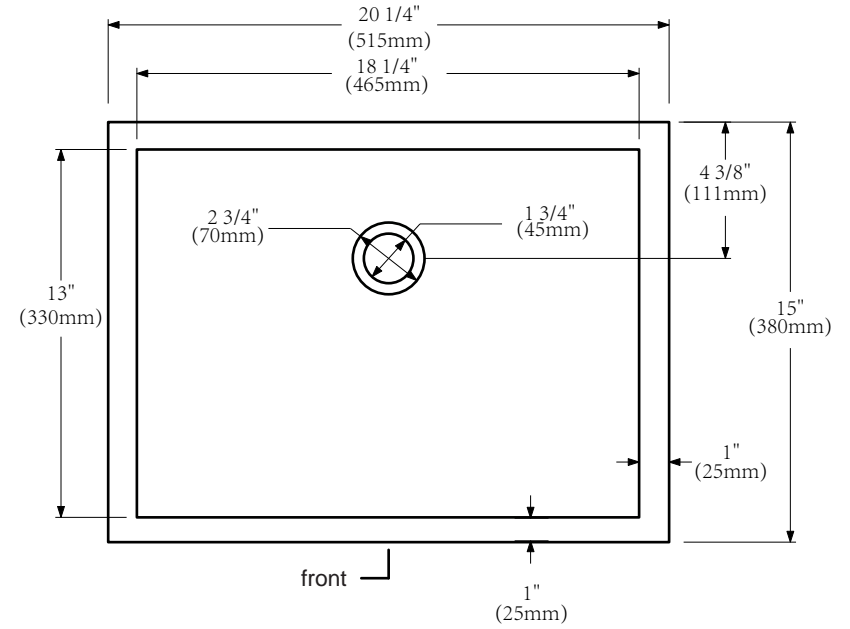
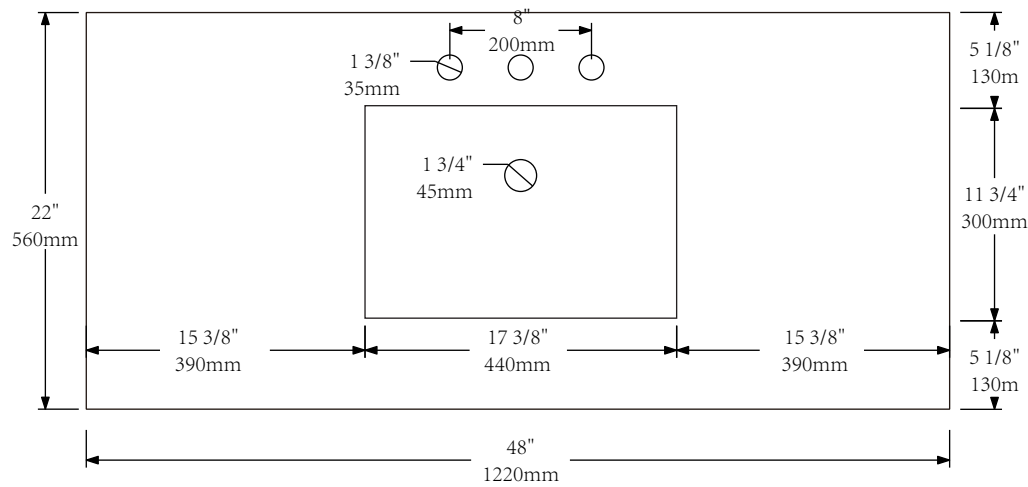



MODEL: RET-M-2136

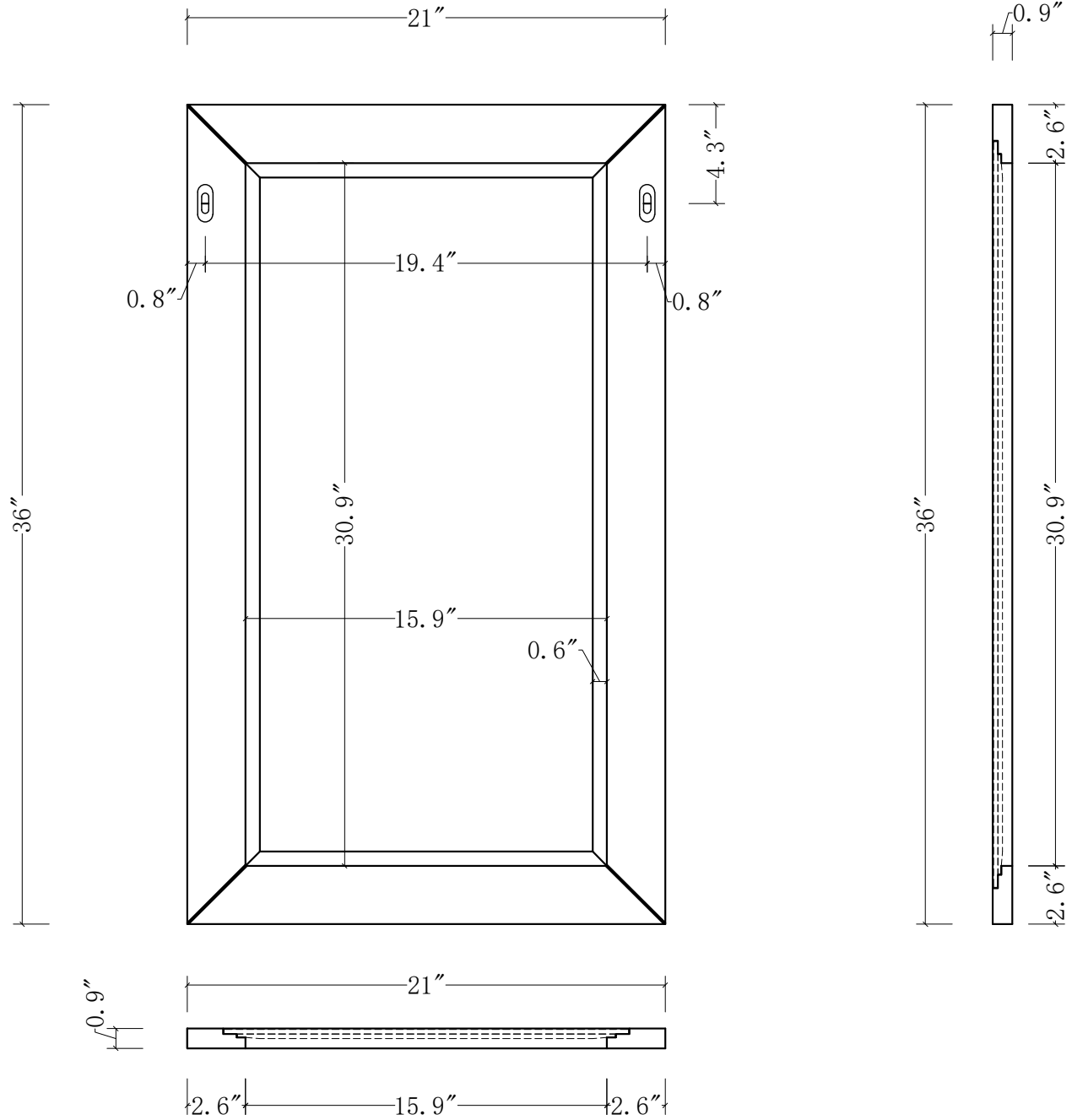



MODEL: F2-0012

