

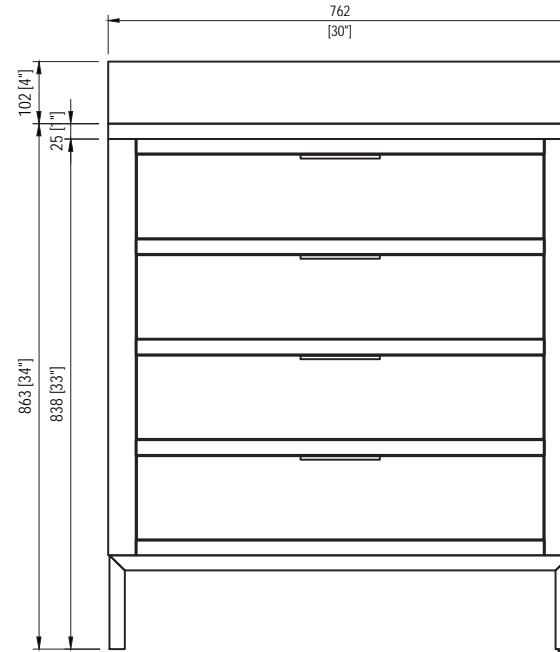

MODEL: BRISTOL 30

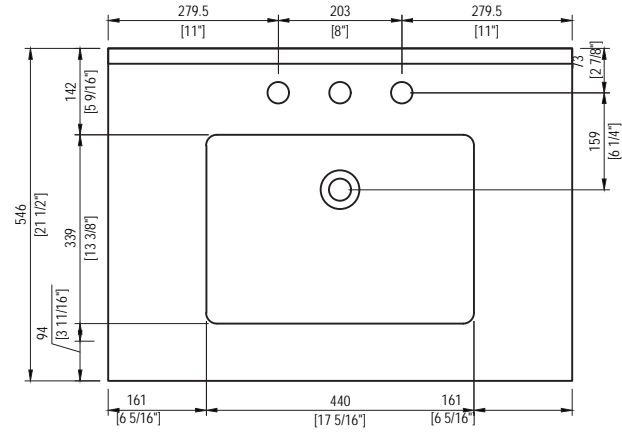

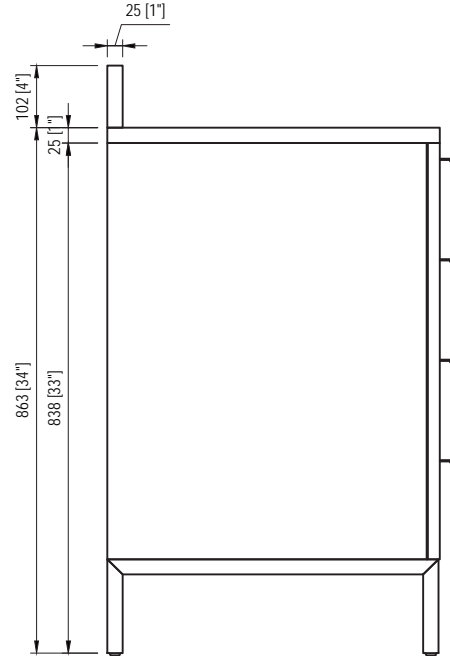

MODEL: BRISTOL 30

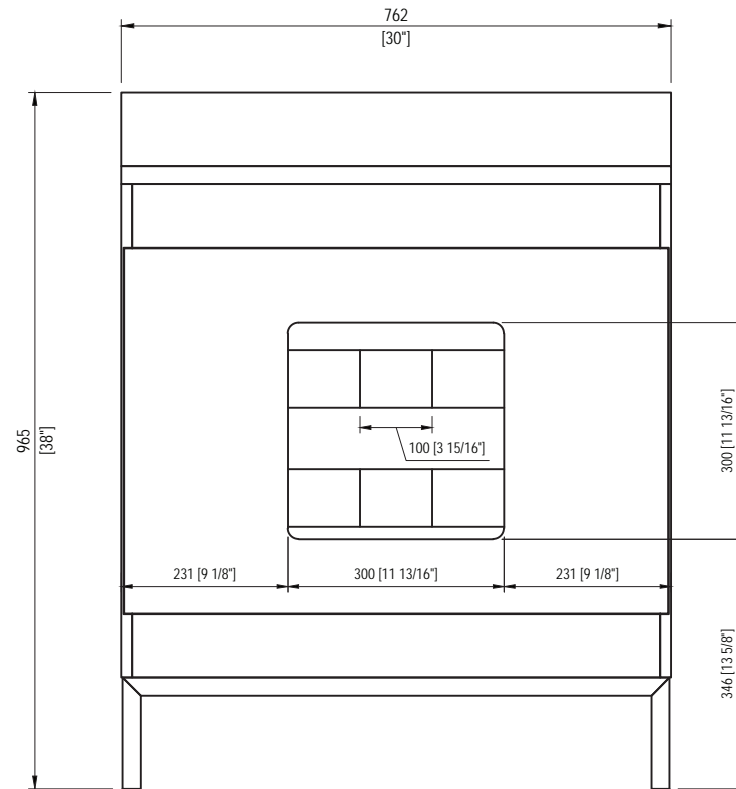



MODEL: BRISTOL 30

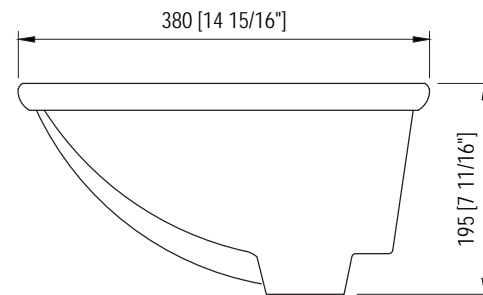
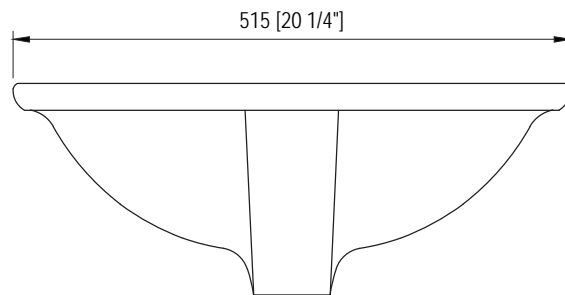
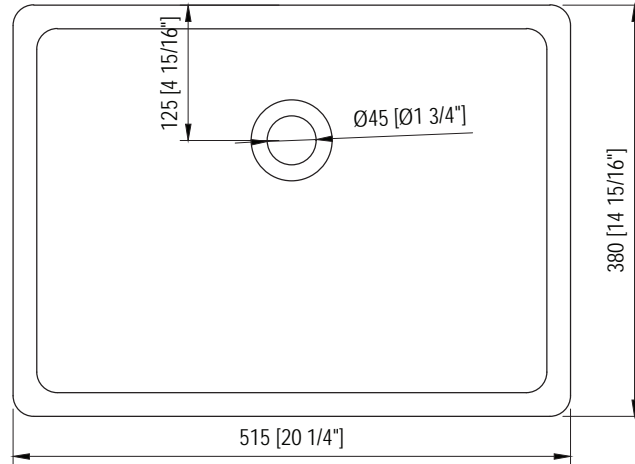



MODEL: BRISTOL 30

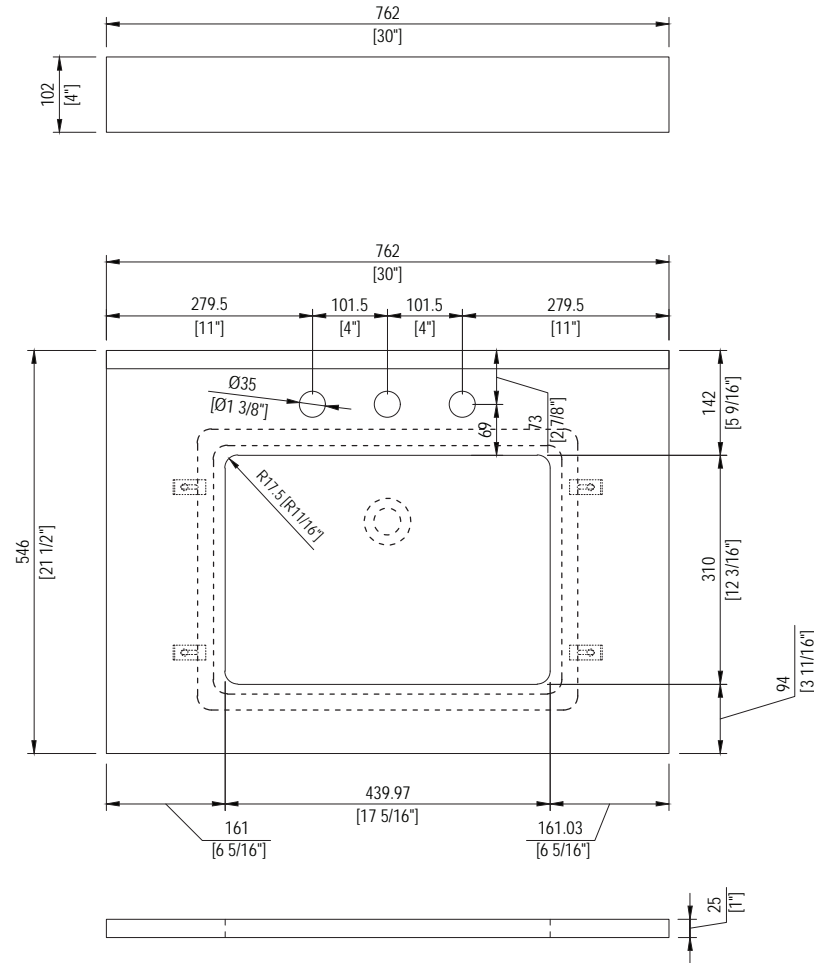



MODEL: BRISTOL 30

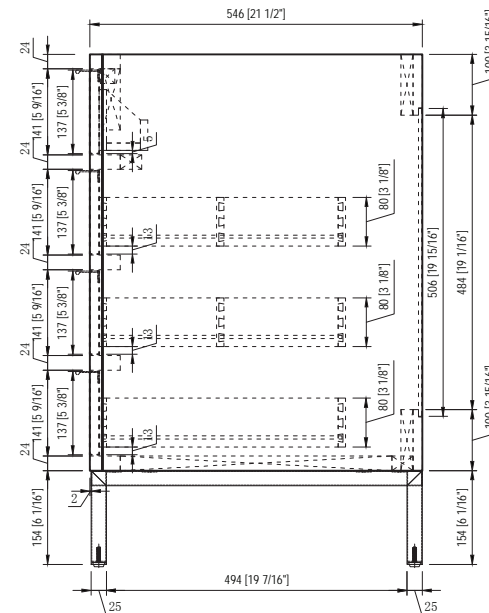
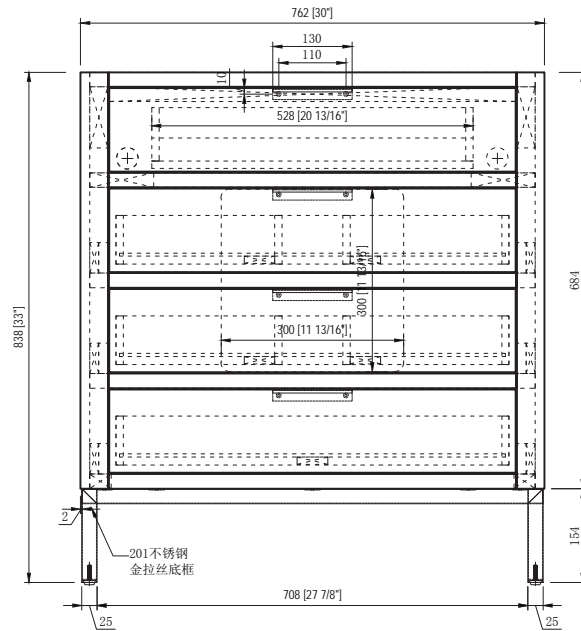
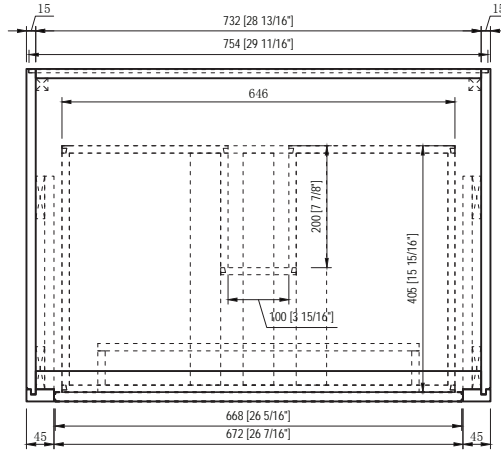



MODEL: F2-0014

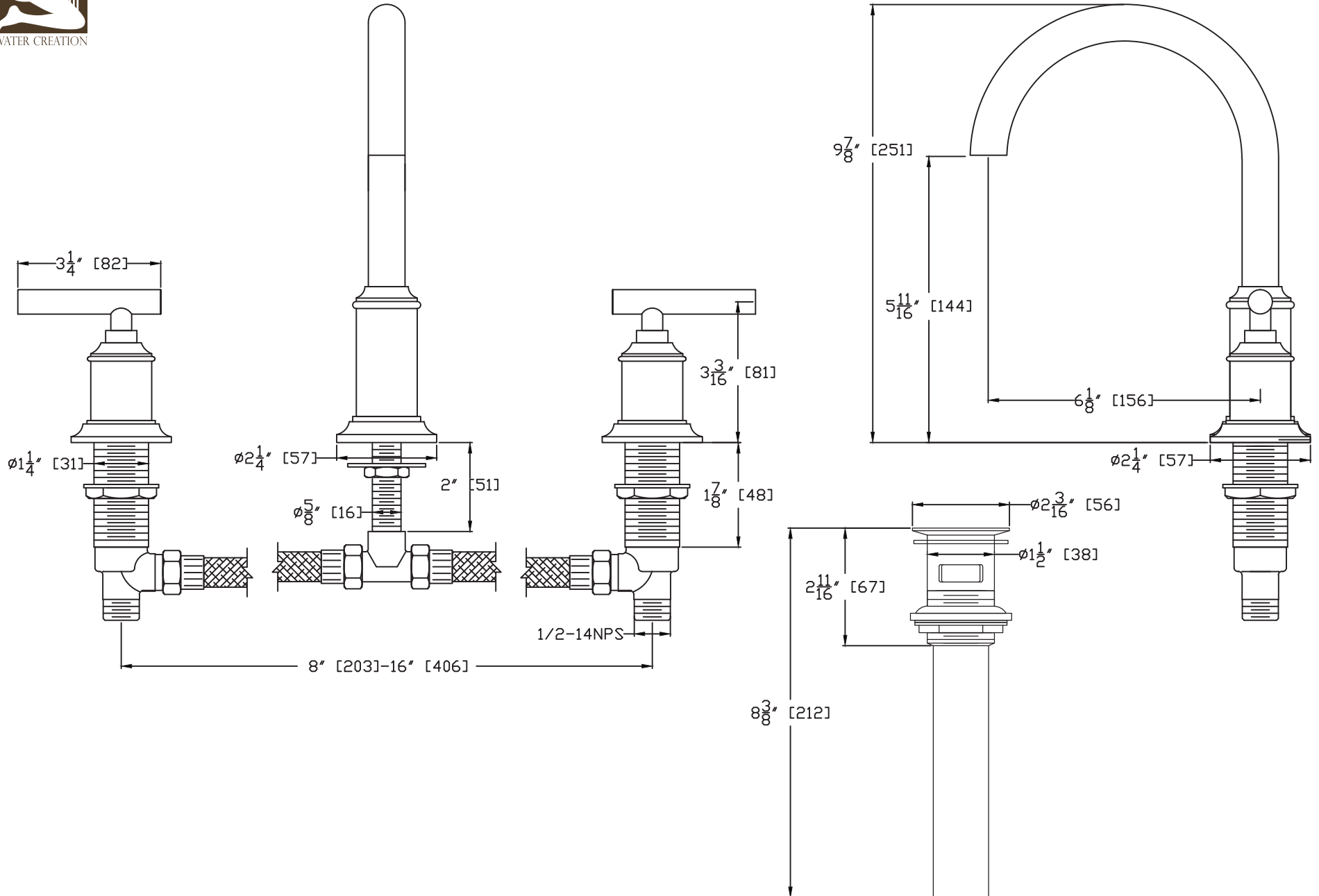



MODEL: RET-M-2136

